

LANDA®

luce italiana

Classic Collection
1st edition

1.28 sec.

is the time that
the #light takes
to get from the #moon
to the #earth.

[il tempo che impiega
la #luce dalla #luna
ad arrivare sulla #terra.]

INTRO

- 4** index by family
- 12** index by mounting
- 14** company profile

PRODUCTS

- 28** amalfi
- 38** augusta
- 44** brick light
- 50** cipro
- 54** firenze
- 60** lampara
- 66** lyras
- 70** maiorca
- 74** monaco
- 80** morphis
- 90** neway
- 96** nizza
- 102** orion
- 112** oslo
- 116** parigi
- 128** pisa
- 132** polos
- 138** rio
- 142** romantica
- 152** sirio
- 156** titano
- 164** pole

INFO

- 175** accessories
- 180** how to read the catalogue
- 182** installation
- 186** family abacus
- 184** index by code
- 187** general information
- 187** quality certifications
- 188** finishes
- 189** terms & conditions

Index by family

AMALFI



AMALFI MINI
> 30



AMALFI MINI
> 30



AMALFI MINI
> 30

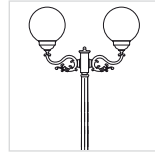

AMALFI MINI
> 30

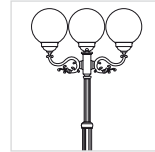

AMALFI MINI
> 30

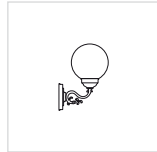

AMALFI
> 32



AMALFI
> 32



AMALFI
> 32

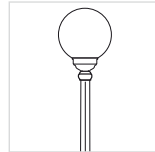

AMALFI
> 32

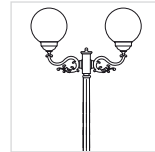

AMALFI
> 32

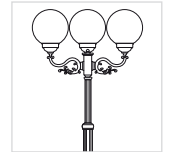

AMALFI
> 32



AMALFI SHORT
> 34



AMALFI SHORT
> 34

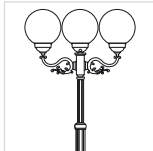

AMALFI SHORT
> 34



AMALFI MAXI
> 36



AMALFI MAXI
> 36

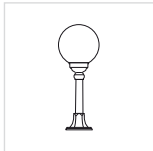

AMALFI MAXI
> 36

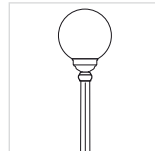

AMALFI MAXI
> 36

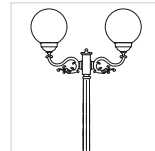

AMALFI MAXI
> 36

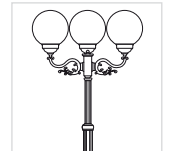

AMALFI MAXI
> 36

AUGUSTA

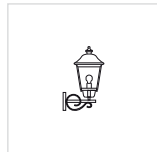

AUGUSTA
> 40



AUGUSTA
> 40

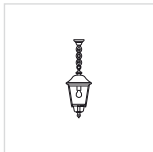

AUGUSTA
> 40



AUGUSTA
> 40



AUGUSTA
> 40



AUGUSTA
> 40



AUGUSTA
> 42



AUGUSTA
> 42

BRICK LIGHT

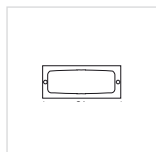
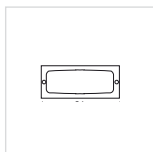
BRICK LIGHT
> 46BRICK LIGHT
> 46BRICK LIGHT
INOX
> 48BRICK LIGHT
INOX
> 48

CIPRO

CIPRO
> 52

FIRENZE

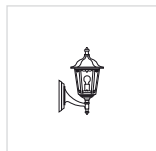
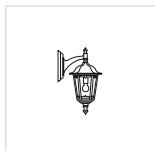
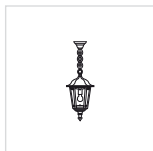
FIRENZE
> 56FIRENZE
> 56FIRENZE
> 56FIRENZE
> 56FIRENZE
> 56FIRENZE
> 58FIRENZE
> 58FIRENZE
> 58

LAMPARA

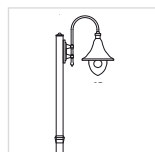
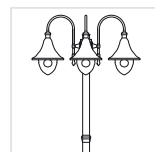
LAMPARA_1
> 62LAMPARA_1
> 62LAMPARA_1
> 62LAMPARA_1
> 62LAMPARA_1
> 62LAMPARA_1
> 62LAMPARA_2
> 64LAMPARA_2
> 64LAMPARA_2
> 64LAMPARA_2
> 64LAMPARA_2
> 64LAMPARA_2
> 64

Index by family

LYRAS 80.1

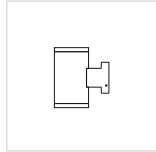

LYRAS 80.1
> 68

MAIORCA



MAIORCA
> 72

MONACO



MONACO
> 76



MONACO
> 76

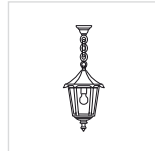

MONACO
> 76

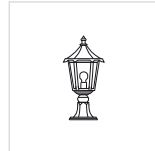

MONACO
> 76



MONACO
> 76



MONACO
> 76



MONACO
> 78



MONACO
> 78



MONACO
> 78

MORPHIS



MORPHIS_1
> 82



MORPHIS_1
> 82



MORPHIS_1
> 82



MORPHIS_1
> 82

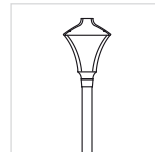

MORPHIS_1
> 82



MORPHIS_2
> 84



MORPHIS_2
> 84

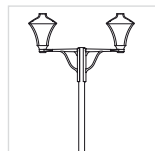

MORPHIS_2
> 84

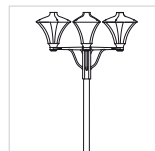

MORPHIS_2
> 84



MORPHIS_3
> 86



MORPHIS_3
> 86



MORPHIS_3
> 86



MORPHIS_3
> 86



MORPHIS_3
> 86



MORPHIS
WALL_1
> 88

NEWAY



NEWAY
> 92

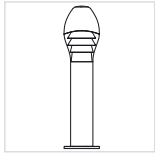

NEWAY
> 94

NIZZA



NIZZA_1
> 98



NIZZA_1
> 98



NIZZA_1
> 98



NIZZA_1
> 98



NIZZA_1
> 98



NIZZA_1
> 98



NIZZA_1
> 98



NIZZA_1
> 98

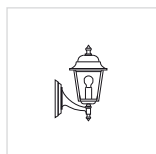

NIZZA_2
> 100



NIZZA_2
> 100



NIZZA_2
> 100



NIZZA_2
> 100



NIZZA_2
> 100

Index by family

ORION



ORION_1
> 104

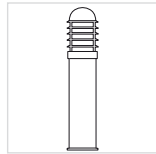

ORION_1
> 104



ORION_2
> 106

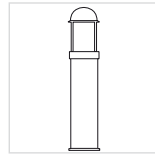

ORION_2
> 106



ORION INOX_1
> 108

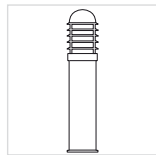

ORION INOX_1
> 108



ORION INOX_2
> 110

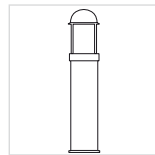

ORION INOX_2
> 110

OSLO



OSLO
> 114

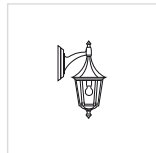

OSLO
> 114



OSLO
> 114



OSLO
> 114



OSLO
> 114



OSLO
> 114

PARIGI



PARIGI MINI
> 118



PARIGI MINI
> 118



PARIGI MINI
> 118



PARIGI MINI
> 118



PARIGI MINI
> 118



PARIGI MINI
> 118



PARIGI MINI
> 118

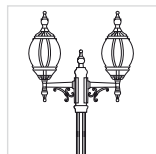

PARIGI MINI
> 118

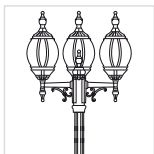

PARIGI MINI
> 118



PARIGI_1
> 120



PARIGI_1
> 120



PARIGI_2
> 122



PARIGI_2
> 122



PARIGI_2
> 122



PARIGI_2
> 122



PARIGI_2
> 122



PARIGI_2
> 122

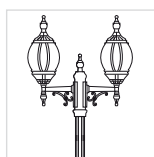

PARIGI_2
> 122

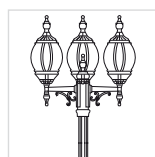

PARIGI_2
> 122



PARIGI MAXI_1
> 124



PARIGI MAXI_1
> 124



PARIGI MAXI_2
> 126



PARIGI MAXI_2
> 126



PARIGI MAXI_2
> 126

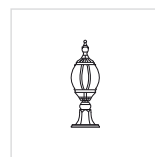

PARIGI MAXI_2
> 126



PARIGI MAXI_2
> 126



PARIGI MAXI_2
> 126



PARIGI MAXI_2
> 126

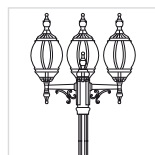

PARIGI MAXI_2
> 126

PISA



PISA
> 130



PISA
> 130



PISA
> 130

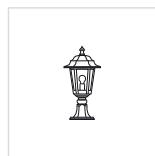

PISA
> 130



PISA
> 130



PISA
> 130

POLOS



POLOS_1
> 134

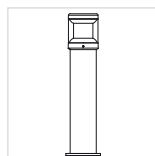

POLOS_1
> 134

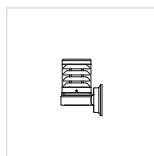

POLOS_2
> 136

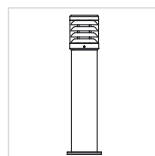

POLOS_2
> 136

RIO

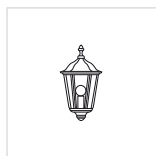

RIO
> 140

Index by family

ROMANTICA



ROMANTICA
> 144



ROMANTICA
> 144



ROMANTICA
> 144



ROMANTICA
> 144



ROMANTICA
> 144



ROMANTICA
> 144



ROMANTICA
> 146

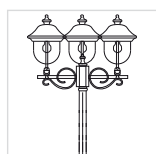

ROMANTICA
> 146



ROMANTICA_1
> 148



ROMANTICA_1
> 148



ROMANTICA_1
> 148



ROMANTICA_1
> 148



ROMANTICA_1
> 148



ROMANTICA_1
> 148



ROMANTICA_1
> 150

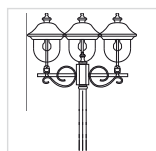

ROMANTICA_1
> 150

SIRIO



SIRIO
> 154

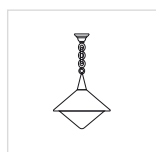

SIRIO
> 154



SIRIO
> 154

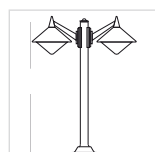

SIRIO
> 154

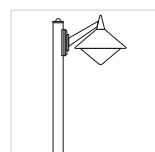

SIRIO
> 154

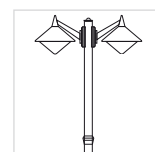

SIRIO
> 154

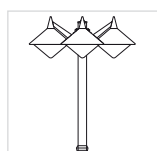

SIRIO
> 154

TITANO

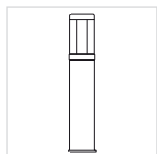
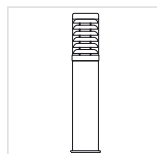
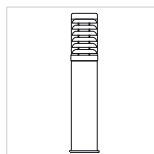
TITANO_1
> 158TITANO_2
> 160TITANO INOX
> 162

Index by mounting

WALL RECESSED

46	brick light	48	brick light inox
----	-------------	----	------------------

WALL LAMPS

30	amalfi_mini	104	orion_1
32	amalfi	106	orion_2
34	amalfi_short	108	orion inox_1
36	amalfi_maxi	110	orion inox_2
40	augusta	114	oslo
52	cipro	118	parigi mini
56	firenze	120	parigi_1
62	lampara_1	122	parigi_2
64	lampara_2	124	parigi maxi_1
68	lyras 80.1	126	parigi maxi_2
72	maiorca	130	pisa
76	monaco	134	polos_1
84	morphis_2	136	polos_2
86	morphis_3	140	rio
88	morphis wall_1	144	romantica
92	neway	148	romantica_1
98	nizza_1	154	sirio
100	nizza_2		

PENDANTS

40	augusta	114	oslo
56	firenze	118	parigi mini
62	lampara_1	122	parigi_2
64	lampara_2	126	parigi maxi_2
76	monaco	130	pisa
86	morphis_3	144	romantica
98	nizza_1	148	romantica_1
100	nizza_2	154	sirio

BOLLARDS

30	amalfi_mini	76	monaco
32	amalfi	82	morphis_1
36	amalfi_maxi	94	neway
40	augusta	98	nizza_1
56	firenze	100	nizza_2
62	lampara_1	104	orion_1
64	lampara_2	106	orion_2

108	orion inox_1	136	polos_2
110	orion inox_2	144	romantica
114	oslo	148	romantica
118	parigi mini	154	sirio
122	parigi_2	158	titano_1
126	parigi maxi_2	160	titano_2
130	pisa	162	titano inox
134	polos_1		

POLES

30	amalfi_mini	84	morphis_2
32	amalfi	86	morphis_3
34	amalfi_short	98	nizza_1
36	amalfi_maxi	114	oslo
40	augusta	118	parigi mini
42	augusta	122	parigi_2
56	firenze	126	parigi maxi_2
58	firenze	130	pisa
62	lampara_1	144	romantica
64	lampara_2	146	romantica
76	monaco	148	romantica
78	monaco	150	romantica
82	morphis_1	154	sirio

Landa Illuminotecnica was founded and grew up in Lumezzane, Brescia, a thriving area of Northern Italy known for its strong business drive that, over the years, led the Company to stand out in several production and industrial sectors.

IT Landa Illuminotecnica nasce e cresce a Lumezzane, Brescia, fiorente area del Nord Italia conosciuta per il suo forte spirito imprenditoriale che, negli anni, l'ha portata a distinguersi in diversi settori produttivi e industriali.

who we are

Present on the light market since 1987, Landa has established itself with its wide range of outdoor luminaires for the residential sector, not only at European level but also and primarily at international level.

The entire production takes place in its plants in Lumezzane, thus allowing constant monitoring of all process steps, from conception to testing, up to the time of shipment.

The company boasts a highly qualified design team that not only manages to meet the needs of the customers, but is also committed to anticipating new needs and new trends, and assisting the customer in the post installation phase.

Over the years all this has allowed a continuous growth in what is one of the most competitive markets in the world, the lighting market.

IT Presente sul mercato della luce dal 1987, Landa si è affermata con la sua ampia gamma di lampade da esterno per il settore residenziale, non solo su scala europea ma, in maniera preponderante, anche a livello internazionale.

L'intera produzione avviene all'interno degli stabilimenti di Lumezzane, consentendo così un costante monitoraggio di tutte le fasi produttive, dall'ideazione al collaudo, fino al momento della spedizione.

L'azienda vanta al suo interno un'equipe di progettazione altamente qualificata che non solo riesce a soddisfare le esigenze presentate dalla clientela, ma è anche attenta ad anticipare i nuovi bisogni ed i nuovi trend del gusto, affiancando poi il cliente anche nella fase successiva all'installazione.

Tutto ciò, negli anni, ha permesso una continua crescita in quello che è uno dei mercati più competitivi al mondo, quello del lighting.

01. 1987

Landa Illuminotecnica is founded as a manufacturing company of lighting fixtures for outdoor use in the residential sector.

IT Nasce Landa Illuminotecnica, azienda produttrice di apparecchi lighting per l'outdoor del settore residenziale.



02. 1990

Launch of the Orion Series, Landa's first iconic product.

IT Vede la luce Serie Orion, il primo prodotto icona di Landa.

03. 1997

Internal implementation of the production and painting systems in the Landa factories.

IT Avviene l'implementazione interna degli impianti di produzione e verniciatura negli stabilimenti Landa.



04. 2002

Launch of the Ibis Series, a product that marked the company's success in the early 2000s.

In 2002 Landa participates for the first time in Light+Building, an important international specialist trade fair held in Frankfurt (Germany), and in Euroluce (Milan), where it will become a constant presence in each of the subsequent editions.

IT Nasce Serie Ibis, prodotto che segna il successo dell'azienda nei primi anni 2000.

È in quest'anno che Landa partecipa per la prima volta a Light+Building, importante fiera internazionale di settore che si svolge nella città tedesca di Francoforte, ed Euroluce (Milano), dove sarà presente poi in ciascuna delle edizioni successive.



05. 2007

Thanks to a major project aiming at expanding production and business, the architectural structure of the Landa headquarters increases to 10,000 from the original 3,000 square meters.

IT Grazie ad un importante progetto di ampliamento produttivo e aziendale, la struttura architettonica sede della Landa arriva a misurare da 3.000 a 10.000 m².



06. 2011

The LED revolution expands the Landa catalogue and product range. Morphis is the new iconic luminaire.

IT La rivoluzione del LED amplia il catalogo e la gamma prodotti Landa. Si sviluppa Morphis, il nuovo apparecchio icona.

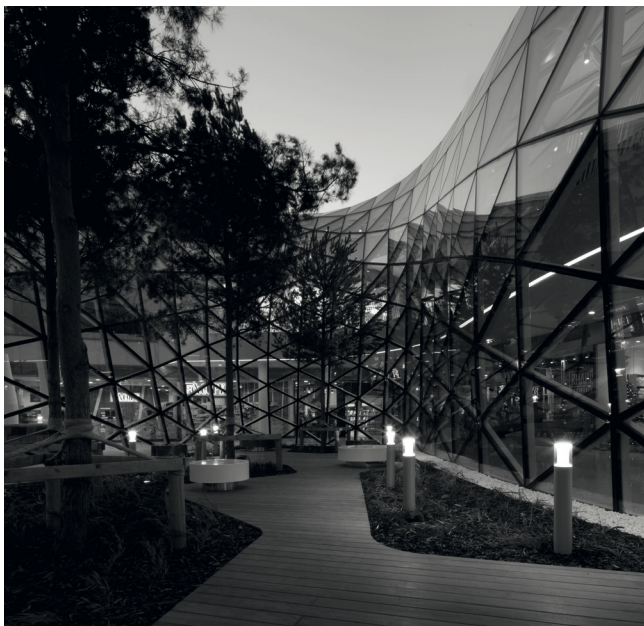

07. 2012-2014

Important international collaborations start. In the following three years, Germany, India and the USA are among the main players that determine the Landa's success abroad, beyond national borders.

IT Hanno inizio le importanti collaborazioni internazionali. Nei tre anni successivi saranno, tra i player principali, Germania, India e USA a determinare il successo di Landa all'estero, al di fuori dei confini nazionali.

08. 2015

New completion of the range with built-in products.

IT Nuovo completamento della gamma con prodotti da incasso.



09. 2018

The year of awareness. To continue to be a reference in the sector, the company vision is expanded with the inclusion of an Art Director: new products, new projects, the same trademark. Landa excellence grows and develops towards new horizons.

IT L'anno della consapevolezza. Per continuare a essere un punto di riferimento nel settore, si amplia la vision dell'azienda con l'inserimento della figura di un Art Director: nuovi prodotti, nuovi progetti, stesso marchio di fabbrica. L'eccellenza Landa cresce e si sviluppa verso nuovi orizzonti.



After the rebranding which returned it, once again, to the position of protagonist on the national and international scene, [LND] opens itself to a new hybrid and spontaneous conception of co-existence, outlining a concept with a strong capacity to attract. The creation and production of light fittings incorporate and integrate these two perspectives in an organic way. So, organic lighting palettes (Nest, Firefly) are born for a developed nature, accompanying, at the same time, an engineered intellect, (Kuboid, Car-Go, Eye, Fog and I-Lantern). The range of products [LND] lives in a coherent dimension, in this way making the work of project designers and prescribers highly free. Equipped with a strong identity, they live for an outdoor dimension integrated with nature and architecture, giving volume and shape to any project requirement.

IT Dopo il rebranding che l'ha portata di nuovo a essere protagonista del panorama nazionale e internazionale, [LND] si apre a una nuova concezione ibrida e spontanea di co-esistenza, delineando un concept dalla forte capacità attrattiva. L'ideazione e la realizzazione di apparecchi illuminanti incorpora e integra in modo organico queste due prospettive. Nascono, così, per una natura potenziata tavolozze vegetali illuminate (Nest, Firefly) che si accompagnano, di pari passo, ad un intelletto ingegnerizzato (Kuboid, Car-Go, Eye, Fog e I-Lantern). La gamma di prodotti [LND] vive in una dimensione coerente, rendendo così altamente libero il lavoro dei progettisti e dei prescrittori. Dotati di una forte identità, vivono per un outdoor integrato con la natura e l'architettura, dando volume e forma a qualsiasi esigenza progettuale.

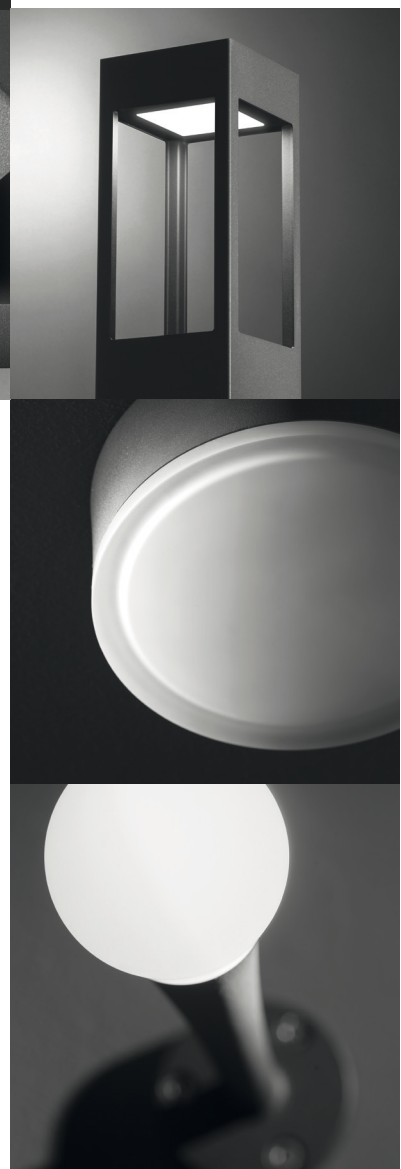

[LND] reinterprets its own philosophy, transforming outdoor aesthetics into unexpected and charming ways.

Efficiency and performance, imperative and steadfast aspects in the company's production, are now part of a transversal thought that turns to the decorative and contemplates the inimitable authenticity of Nature.

This is how the **collection** was born. **Unexpected**. A story that narrates, made of discrete geometries and lighting accents, that are **protagonists of an organic dialogue** with the surrounding world. The new Landa lighting chapter rediscovers a dreamlike dimension, opening itself to visions that can make **matter live in synergy with the spirit of Nature**.



IT [LND] reinterpreta la propria filosofia, trasformando l'estetica outdoor in modi inattesi e suggestivi.

L'efficienza e la performance, imperativi saldi nella produzione dell'azienda, sono ora parte di un pensiero trasversale che volge al decorativo e che contempla l'inimitabile autenticità della Natura.

*Nasce, così, la **collezione Unexpected**. Una storia da raccontare fatta di geometrie discrete e accenti luminosi, che sono **protagonisti di un dialogo organico** con il mondo circostante. Il nuovo capitolo dell'illuminazione [LND] riscopre una dimensione onirica, aprendosi a visioni capaci di far vivere la materia in sinergia con lo spirito della Natura.*

UNEXPECTED

&CO/LLECTION



&CO/LLECTION is the new range of products made in [LND].

They originate from the wish to **find a new place for light in its natural environment: nature**. With awareness, we have maintained all the bio-aspect features of the materials to be able to give you a new anthology of organic light.

It is for this very reason that, in this collection, you will never find aesthetically perfect products, with an icy cold, industrial look. For this reason we have taken the names of this collection from the Cactus family. The beauty of this variety of plants is that although they are all very similar, due to their thorns, aesthetic conformation and properties, they are always different from each other in shape and size.

Uniqueness in diversity has been our design leitmotiv.

IT &CO/LLECTION è la nuova gamma di prodotti made in [LND].

*Nasce dalla volontà di **ri-collocare la luce nel suo ambiente naturale: la natura**. Con coscienza, abbiamo mantenuto tutte le caratteristiche di bio-aspetto dei materiali per potervi dare una nuova antologia di luce organica.*

Proprio per questo motivo non troverete mai, in questa collezione, prodotti esteticamente perfetti, dall'aspetto algido e industriale. Per questo motivo abbiamo preso a piene mani i nomi di questa collezione dalla famiglia delle Cactacee. Il bello di queste varietà di piante è che pur essendo tutte molto simili, per via delle spine, della conformazione estetica e delle proprietà, sono sempre diverse l'una dall'altra per forma e dimensioni.

L'unicità nella diversità è stato il nostro leitmotiv di progettazione.

Landa Illuminotecnica is part of the **Bugatti La San Marco S.a.p.a. Group**, an important reality born from the initiative of the family new generations, who have allowed the evolution of the original Bugatti Company, founded in 1923 and operating in the field of cutlery and furnishings.

Bugatti Group

*IT Landa Illuminotecnica fa parte del **Gruppo Bugatti La San Marco S.a.p.a.**, importante realtà nata dall'intraprendenza delle nuove generazioni della famiglia, le quali hanno saputo evolvere quella che era la società Bugatti, nata nel 1923 e operante nel settore della posateria e degli articoli di arredamento.*





BUGATTI® 100
Group SINCE 1923

BUGATTI

Since 1923, Bugatti manufactures cutlery, kitchen appliances and table- and kitchenware. Thanks to the cooperation with designers and draughtsmen, Bugatti produces small and big jewels that surprise and enrich the daily habits and our domestic ambiances, taking marvel and an unexpected touch into daily life.

IT Dal 1923 Bugatti realizza posate, piccoli elettrodomestici e oggettistica per la tavola e cucina. Grazie alle collaborazioni con designer e progettisti, produce piccoli e grandi gioielli, volti a stupire e arricchire le abitudini e gli ambienti di vita, portando un tocco inaspettato e meraviglia nella quotidianità delle persone.

AIGNEP

Aignep operates in the "Automation Fluid Technology" sector and provides solutions in fluid technology. Today, it is a consolidated reality with 10 branches worldwide and through exclusive distributors in 102 countries.

IT Aignep è attiva nel settore "Automation Fluid Technology" e fornisce soluzioni nella tecnologia dei fluidi. Oggi è una realtà consolidata con 10 filiali nel mondo ed è presente con distributori esclusivi in 102 paesi.

[LND]

Landa, on the lighting market since 1987, designs and manufactures outdoor lighting for the residential sector with a global distribution network.

IT Landa, presente nel mercato dell'illuminazione dal 1987, progetta e produce apparecchi da esterno per il settore residenziale con una rete di distribuzione globale.



Picchi manufactures Transfer Machines and CNC Machining Centers, machine tools and special machines with high productivity requirements and low operating costs, responding to the needs of customers coming from different sectors.

IT Picchi realizza Macchine Transfer e Centri di Lavoro CNC, macchine utensili e macchine speciali dai requisiti di alta produttività e costi di esercizio contenuti, rispondendo alle esigenze di clienti in settori diversificati.

idroimpianti

Idroimpianti is based in Italy and comprises a hydroelectric power station as well as several photovoltaic systems. Born in 2018 as a concrete response to the Group's desire to operate in a more sustainable way.

IT Idroimpianti comprende una centrale idroelettrica e diversi impianti fotovoltaici con sede in Italia. Nasce nel 2018 come risposta concreta all'esigenza del Gruppo di avere un impatto più sostenibile nella propria attività.

PRODUCTS

Amalfi

design by Landa R&D

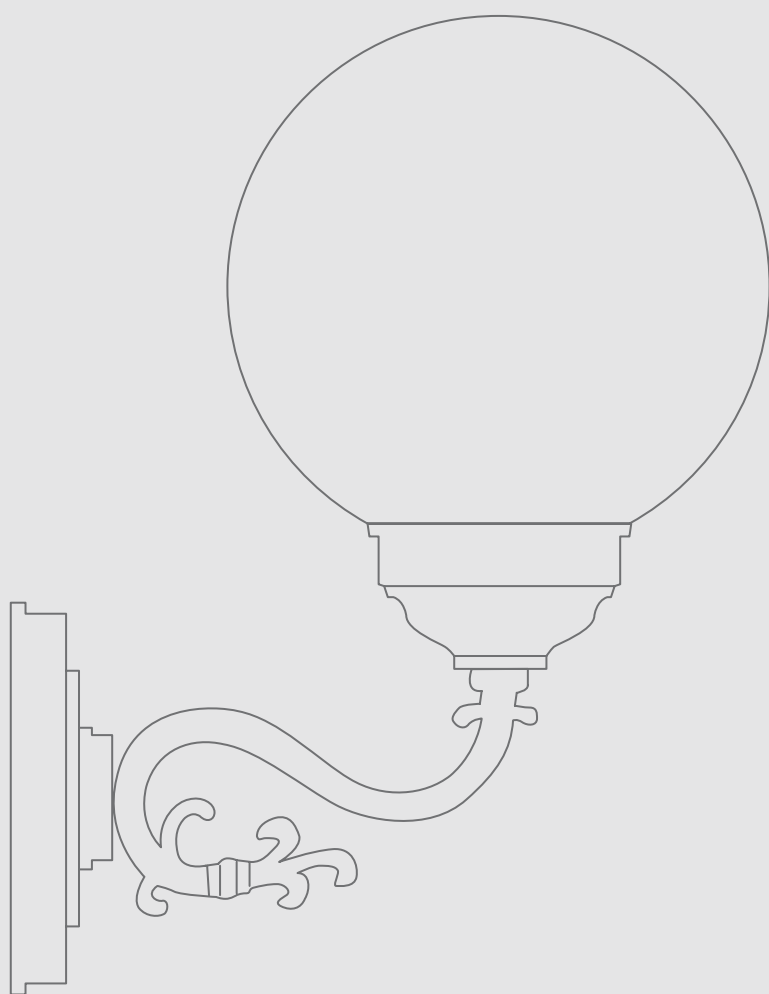

WALL LAMP

BOLLARD

POLE

EN Amalfi is a wall, bollard and pole mounting luminaire with a spherical opal PMMA diffuser in three different sizes.

The pole, the bollard and the wall mounting support, in EN47100 die-cast aluminium available in 4 finishes, evoke the iconic Baroque shapes for a product that is as poetic and evocative as the coast from which it takes its name.

IT Amalfi è un apparecchio per applicazioni da parete, da bollard e da palo con diffusore in PMMA opale dalla forma sferica in tre diverse dimensioni.

Il palo, il bollard e il supporto di fissaggio a muro, in alluminio pressofuso EN47100 disponibile in 4 finiture, rievocano le iconiche forme barocche per un prodotto poetico ed evocativo, come la costa da cui prende il nome.

Amalfi Mini

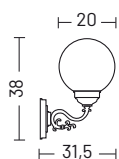

upwards wall lamp
cod. 00

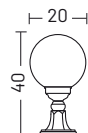

bollard
cod. 33

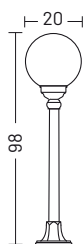

bollard
cod. 44

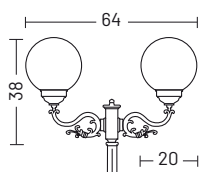

2 lights head
cod. T2

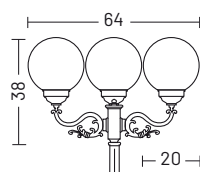

3 lights head
cod. T3

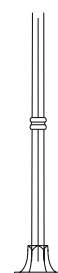

Pole
cod. PF5







Pole
cod. PR7

MATERIALS

Body	Die-cast aluminium EN47100
Diffuser	Opal PMMA
Finishing	Polyester powder paint





ORDER CODE

WALL LAMP | BOLLARD

320	Finishing	G	Black		
		P	Black/Green		
		S	Black/Copper		
		U	White		
	Installation	00	Upwards wall lamp		
		33	Bollard h. 40 cm		
		44	Bollard h. 98 cm		
	Diffuser	.	Opal		

Example 320 . 00 G

POLE 2 OR 3 LIGHTS

320	Finishing	G	Black		
		P	Black/Green		
		S	Black/Copper		
		U	White		
	Lights	T2	2 lights		
		T3	3 lights		
	Pole style	PF5	pole h. 210 cm *		
		PR7	adjustable h. 149-214 cm *		
	Diffuser	.	Opal		

Example 320 . PF5 T2 G

ELECTRIFICATION

Bulb	Base type	Max wattage	Bulb dimension
	E27	25 W	Ø 6 x 12cm

AVAILABLE ACCESSORIES

Code	Description	Page
00APF6	Anchor bolt for poles PF5	177
00APR8	Anchor bolt for poles PR7	177
00108G	Corner bracket	176
0404M003	Loop in loop out IP68	176
0404M004	Single connection IP68	176



* post and head complete height

Amalfi

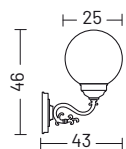

upwards wall lamp
cod. 00



bollard
cod. 33

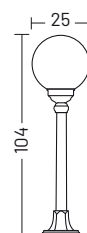

bollard
cod. 44



1 light head

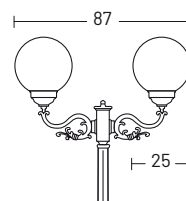

2 lights head
cod. T2

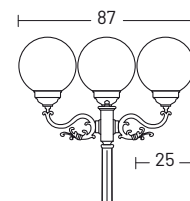

3 lights head
cod. T3

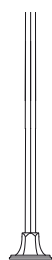

Pole
cod. PF4



Pole
cod. PF7

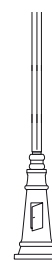

Pole
cod. PE7

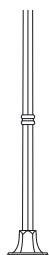

Pole
cod. PF5/PF6

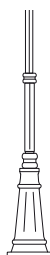

Pole
cod. PF8



Pole
cod. PE8



Pole
cod. PR4

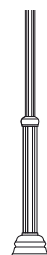

Pole
cod. PR5/PR6



Pole
cod. PR7

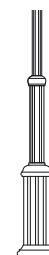





Pole
cod. PR8

MATERIALS





Body	Die-cast aluminium EN47100
Diffuser	Opal PMMA
Finishing	Polyester powder paint

ORDER CODE





WALL LAMP | BOLLARD

322	Finishing	G	Black	
		P	Black/Green	
		S	Black/Copper	
		U	White	
Installation	00	upwards wall lamp		
	33	Bollard h. 40 cm		
	44	Bollard h. 104 cm		
Diffuser	.	Opal		
	Example	322 . 00 G		

POLE 1 LIGHT

322	Finishing	G	Black	
		P	Black/Green	
		S	Black/Copper	
		U	White	
Pole style	PF4	pole 1L h. 149 cm *		
	PF5	pole 1L h. 205 cm *		
	PF6	pole 1L h. 243 cm *		
	PF7	pole 1L h. 185 cm *		
	PF8	pole 1L h. 243 cm *		
	PE7	pole 1L h. 185 cm *		
	PE8	pole 1L h. 243 cm *		
	PR4	pole 1L h. 129 cm *		
	PR5	adjustable h. 119-184 cm *		
	PR6	adjustable h. 138-222 cm *		
PR7	adjustable h. 144-209 cm *			
Diffuser	.	Opal		
	Example	322 . PF5 G		

POLE 2 OR 3 LIGHTS

322	Finishing	G	Black	
		P	Black/Green	
		S	Black/Copper	
		U	White	
Lights	T2	2 lights		
	T3	3 lights		
Pole style	PF8	pole h. 256 cm *		
	PE8	pole h. 256 cm *		
	PR8	adjustable h 187-252 cm *		
Diffuser	.	Opal		
	Example	322 . PF5 T2 G		

ELECTRIFICATION

Bulb	Base type	Max wattage	Bulb dimension
	E27	LED 25W	Ø 6 x 15cm

AVAILABLE ACCESSORIES

Code	Description	Page
00APF6	Anchor bolt for poles PF4/PF5/PF6	177
00APF8	Anchor bolt for poles PF7/PF8/PE7/PE8	177
00APR6	Anchor bolt for poles PR5/PR6	177
00APR8	Anchor bolt for poles PR7/PR8	177
00108G	Corner bracket	176
0404M003	Loop in loop out IP68	176
0404M004	Single connection IP68	176

* post and head complete height

Amalfi Short

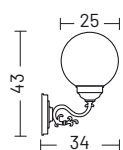

upwards wall lamp
cod. 00

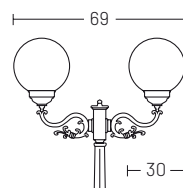

2 lights head
cod. T2

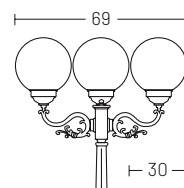

3 lights head
cod. T3

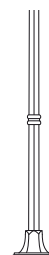

Pole
cod. PF5

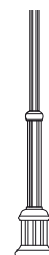

Pole
cod. PR7





MATERIALS

Body	Die-cast aluminium EN47100
Diffuser	Opal PMMA
Finishing	Polyester powder paint

ORDER CODE

WALL LAMP





321.00 _

Finishing	G	Black	
	P	Black/Green	
	S	Black/Copper	
	U	White	
Diffuser	.	Opal	

Example 321 . 00 G

POLE 2 OR 3 LIGHTS

321 _ _ _

Finishing	G	Black	
	P	Black/Green	
	S	Black/Copper	
	U	White	
Lights	T2	2 lights	
	T3	3 lights	
Pole style	PF5	pole h. 218 cm *	
	PR7	adjustable h. 157-222 cm *	
Diffuser	.	Opal	

Example 321 . PF5 T2 G

ELECTRIFICATION

Bulb	Base type	Max wattage	Bulb dimension
	E27	LED 25 W	Ø 6 x 15cm

AVAILABLE ACCESSORIES

Code	Description	Page
00APF6	Anchor bolt for poles PF5	177
00APR8	Anchor bolt for poles PR7	177
00108G	Corner bracket	176
0404M003	Loop in loop out IP68	176
0404M004	Single connection IP68	176



* post and head complete height

Amalfi Maxi

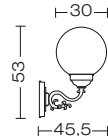

upwards wall lamp
cod. 00

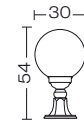

bollard
cod. 33

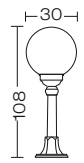

bollard
cod. 44



1 light head

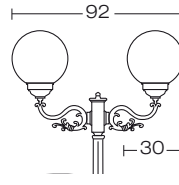

2 lights head
cod. T2

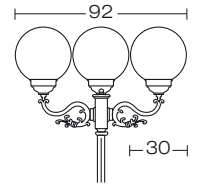

3 lights head
cod. T3

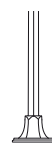

Pole
cod. PF4



Pole
cod. PF7



Pole
cod. PE7

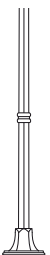

Pole
cod. PF5/PF6



Pole
cod. PF8/PF9



Pole
cod. PE8/PE9



Pole
cod. PR4

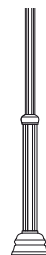

Pole
cod. PR5/PR6

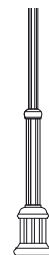

Pole
cod. PR7







Pole
cod. PR8

MATERIALS





Body	Die-cast aluminium EN47100
Diffuser	Opal PMMA
Finishing	Polyester powder paint

ORDER CODE





WALL LAMP | BOLLARD

323	Finishing	G	Black		
		P	Black/Green		
		S	Black/Copper		
		U	White		
	Installation	00	Upwards wall lamp		
		33	Bollard h. 54 cm		
		44	Bollard h. 108 cm		
	Diffuser	.	Opal		
		Example 323 . 00 G			

POLE 1 LIGHT

323	Finishing	G	Black			
		P	Black/Green			
		S	Black/Copper			
		U	White			
	Pole style	PF4	pole 1L h. 156 cm *			
		PF5	pole 1L h. 212 cm *			
		PF6	pole 1L h. 250 cm *			
		PF7	pole 1L h. 192 cm *			
		PF8	pole 1L h. 250 cm *			
		PF9	pole 1L h. 288 cm *			
		PE7	pole 1L h. 192 cm *			
		PE8	pole 1L h. 250 cm *			
		PE9	pole 1L h. 288 cm *			
		PR4	pole 1L h. 136 cm *			
		PR5	adjustable h. 126-191 cm *			
		PR6	adjustable h. 145-229 cm *			
		PR7	adjustable h. 151-216 cm *			
		PR8	adjustable h. 181-246 cm *			
		Diffuser	.	Opal		
			Example 323 . PF5 G			

POLE 2 OR 3 LIGHTS

323	Finishing	G	Black		
		P	Black/Green		
		S	Black/Copper		
		U	White		
	Lights	T2	2 lights		
		T3	3 lights		
	Pole style	PF8	pole h. 263 cm *		
		PF9	pole h. 301 cm *		
		PE8	pole h. 263 cm *		
		PE9	pole h. 301 cm *		
		PR6	adjustable h 162-246 cm *		
		PR8	adjustable h 198-263 cm *		
Diffuser	.	Opal			
	Example 323 . PF8 T3 G				

ELECTRIFICATION

Bulb	Base type	Max wattage	Bulb dimension
	E27	LED 25 W	Ø 6 x 15cm

AVAILABLE ACCESSORIES

Code	Description	Page
00APF6	Anchor bolt for poles PF4/PF5/PF6	177
00APF8	Anchor bolt for poles PF7/PF8/PF9/PE7/PE8/PE9	177
00APR6	Anchor bolt for poles PR5/PR6	177
00APR8	Anchor bolt for poles PR7/PR8	177
00108G	Corner bracket	176
0404M003	Loop in loop out IP68	176
0404M004	Single connection IP68	176

* post and head complete height

Augusta

design by Landa R&D

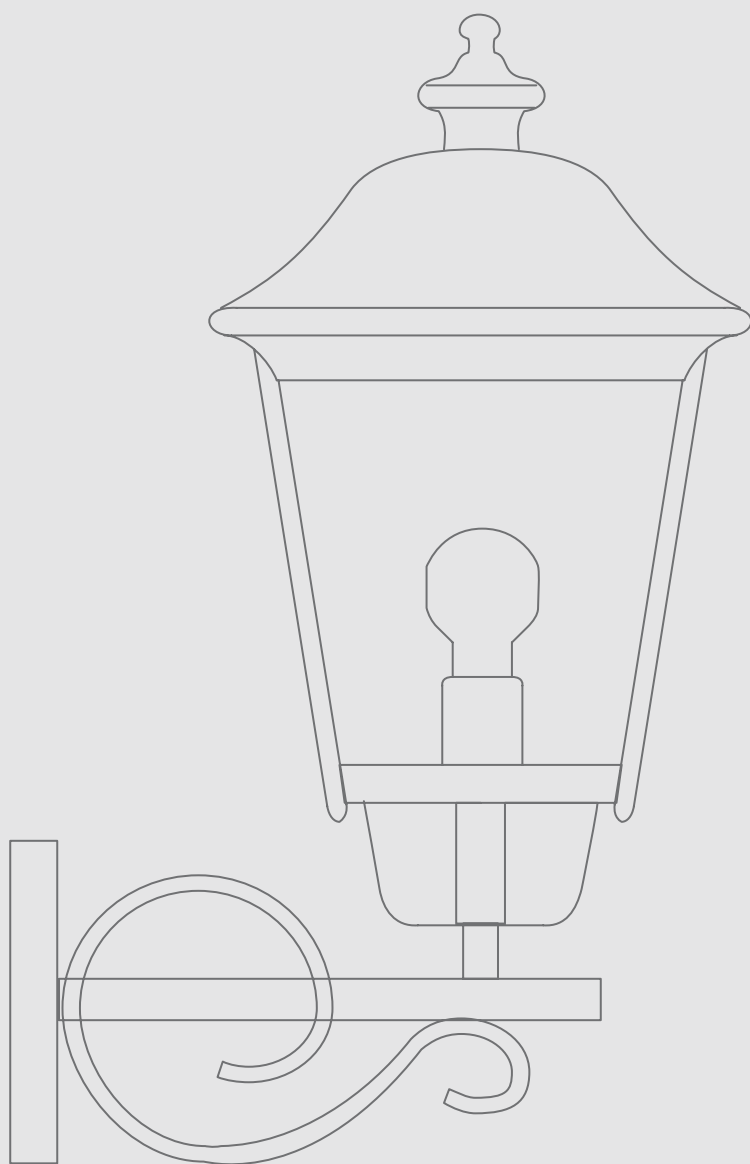

WALL LAMP

PENDANT

BOLLARD

POLE

EN Augusta is a luminaire for wall (in two possible variants), suspension, bollard and pole mounting applications, with a classic yet linear shape.

The diffuser is made of transparent polycarbonate, the finish of the body, in EN47100 die-cast aluminium, is available in 5 colour variants with the option of an aluminium or copper cap.

IT Augusta è un apparecchio per applicazioni da parete (in due varianti possibili), da sospensione, da bollard e da palo, dalla forma classica ma lineare.

Lo schermo è in polycarbonato trasparente, la finitura del corpo, in alluminio pressofuso EN47100, è disponibile in 5 varianti colore con possibilità di avere il cappello in alluminio o in rame.

Augusta



pendant



aluminium top



copper top



upwards wall lamp
cod. 00

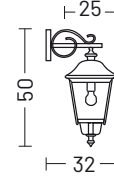

downwards wall lamp
cod. 01

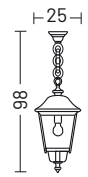

pendant
cod. 02



Bollard
cod. 33

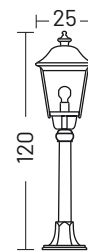

Bollard
cod. 44

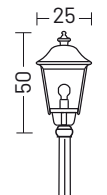

1 light head



Pole
cod. PF4



Pole
cod. PF7



Pole
cod. PE7

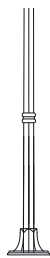

Pole cod.
PF5/PF6

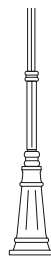

Pole cod.
PF8

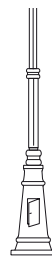

Pole cod.
PE8



Pole cod.
PR4

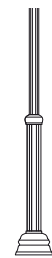

Pole cod.
PR5/PR6

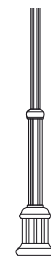





Pole cod.
PR7

MATERIALS





Body	Die-cast aluminium EN47100
Diffuser	Transparent polycarbonate
Finishing	Polyester powder paint

ORDER CODE

WALL LAMP | BOLLARD | PENDANT

360	Finishing	G	Black	
		P	Black/Green	
		R	Black/Silver	
		S	Black/Copper	
		U	White	
	Installation	00	Upwards wall lamp	
		01	Downwards wall lamp	
		02	Pendant	
		33	Bollard h. 58 cm	
		44	Bollard h. 120 cm	
	Variant	.	Aluminium top	
		A	Copper top	
	Example	360 A 00 G		

POLE 1 LIGHT

360	Finishing	G	Black	
		P	Black/Green	
		R	Black/Silver	
		S	Black/Copper	
		U	White	
	Pole style	PF4	pole 1L h. 160 cm *	
		PF5	pole 1L h. 216 cm *	
		PF6	pole 1L h. 254 cm *	
		PF7	pole 1L h. 196 cm *	
		PF8	pole 1L h. 254 cm *	
		PE7	pole 1L h. 196 cm *	
		PE8	pole 1L h. 254 cm *	
	Variant	PR4	pole 1L h. 140 cm *	
		PR5	adjustable h. 130-195 cm *	
		PR6	adjustable h. 149-233 cm *	
Variant	.	Aluminium top		
	A	Copper top		
Example	360 . PF5 G			

ELECTRIFICATION

Bulb	Base type	Max wattage	Bulb dimension
	E27	25 W	Ø 6 x 15cm

AVAILABLE ACCESSORIES

Code	Description	Page
00APF6	Anchor bolt for poles PF4/PF5/PF6	177
00APF8	Anchor bolt for poles PF7/PF8/PE7/PE8	177
00APR6	Anchor bolt for poles PR5/PR6	177
00APR8	Anchor bolt for poles PR7	177
00108G	Corner bracket	176
0404M003	Loop in loop out IP68	176
0404M004	Single connection IP68	176

* post and head complete height

Augusta



aluminium top

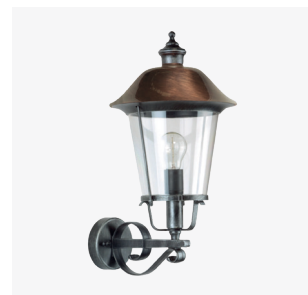

copper top

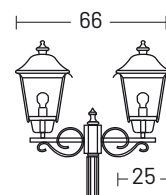

2 lights head
cod. T2

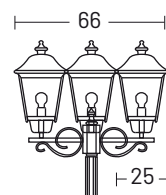

3 lights head
cod. T3

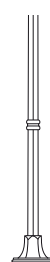

Pole cod.
PF6



Pole cod.
PF8



Pole cod.
PE8

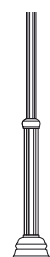

Pole cod.
PR6

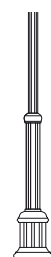

Pole cod.
PR7

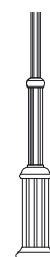





Pole cod.
PR8

MATERIALS

Body	Die-cast aluminium EN47100
Diffuser	Transparent polycarbonate
Finishing	Polyester powder paint

ORDER CODE

POLE 2 OR 3 LIGHTS

360	Finishing	G	Black		
		P	Black/Green		
		R	Black/Silver		
		S	Black/Copper		
		U	White		
	Lights	T2	2 lights		
		T3	3 lights		
	Pole style	PF6	pole adjustable h. 260 cm*		
		PF8	pole adjustable h. 260 cm*		
		PE8	pole adjustable h. 260 cm*		
		PR6	pole adjustable h. 155/239 cm*		
		PR7	pole adjustable h. 161/226 cm*		
		PR8	pole adjustable h. 191/256 cm*		
	Variant	.	Aluminium top		
		A	Copper top		
	Example	360 A PF6 T2 G			

ELECTRIFICATION

Bulb	Base type	Max wattage	Bulb dimension
	E27	25 W	Ø 6 x 15cm

AVAILABLE ACCESSORIES

Code	Description	Page
00APF6	Anchor bolt for poles PF6	177
00APF8	Anchor bolt for poles PF8/PE8	177
00APR6	Anchor bolt for poles PR6	177
00APR8	Anchor bolt for poles PR7/PR8	177
0404M003	Loop in loop out IP68	176
0404M004	Single connection IP68	176

* post and head complete height



Brick Light

design by Landa R&D



WALL RECESSED

EN Brick light is an ideal luminaire for recessed wall installation, providing diffused light to outdoor environments through 5 mm sandblasted and tempered glass. A luminaire available with or without a grill, extremely easy to install; a recessed luminaire in EN47100 die-cast aluminium with a front available in 4 colours and in AISI 316L stainless steel.

IT Brick light è un apparecchio ideale per installazioni ad incasso a parete, in grado di fornire una luce diffusa agli ambienti esterni attraverso un vetro sabbiato e temprato da 5 mm. Un apparecchio disponibile con o senza griglia, estremamente facile da installare; un incasso in alluminio pressofuso EN47100 con frontale disponibile in 4 varianti colore e in acciaio inox AISI 316L.

Brick Light



ALUMINIUM FRAME

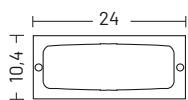

recessed wall lamp
cod. 410

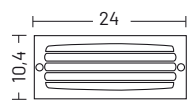

recessed wall lamp
cod. 411

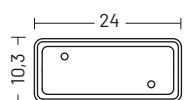
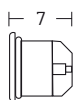

box dimension

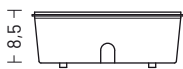

open
cod. 410



striped
cod. 411

MATERIALS





Body	Die-Cast aluminium EN47100
Diffuser	Glass opal
Finishing	Polyester powder paint

ELECTRIFICATION

Bulb	Base type	Max wattage	Bulb dimension
	E27	LED 25 W	Ø 6 x 12cm

ORDER CODE

WALL LAMP

41_ _	Finishing	G	Black	
		H	Grey	
		L	Graphite	
		U	White	
Type	0	Open		
	1	Striped		
Example		411 G		

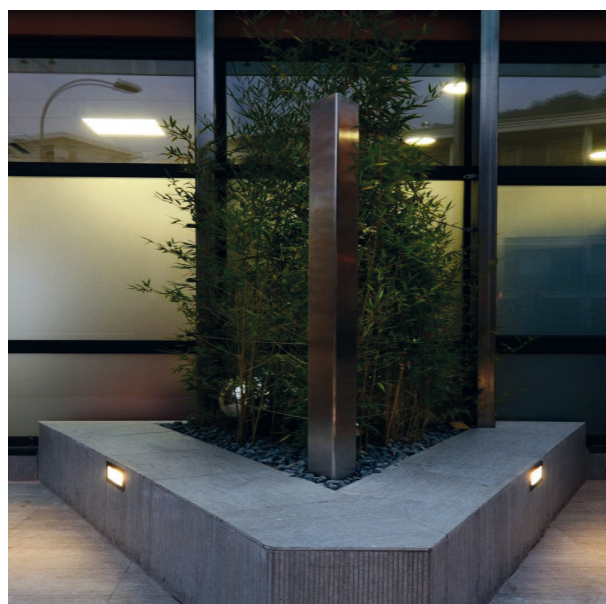

Brick Light Inox



STAINLESS STEEL AISI 316 L

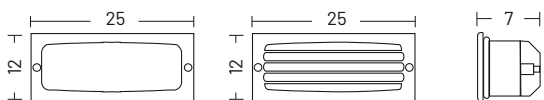

recessed wall lamp
cod. 412Z

recessed wall lamp
cod. 413Z



open inox
cod. 412Z



striped inox
cod. 413Z



box dimension

MATERIALS

Body	Die-Cast aluminium EN47100
Diffuser	Glass opal
Finishing	Stainless steel AISI316L frame

ELECTRIFICATION

Bulb	Base type	Max wattage	Bulb dimension
	E27	LED 25 W	Ø 6 x 12cm

ORDER CODE

WALL LAMP

4L -	Finishing	Z	Stainless steel AISI316L	
	Type	2	Open	
		3	Striped	
Example	413 Z			



Cipro

design by Landa R&D

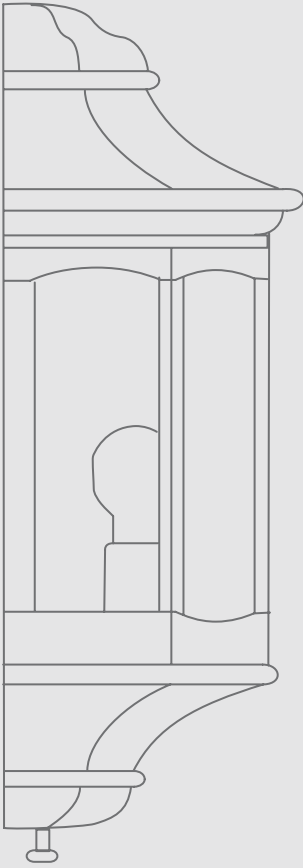

WALL LAMP

EN Cipro is a wall-mounted luminaire with a faceted design. A timeless classic with high performance in terms of resistance.

Available in five different finishes Black, Black/Green, Black/Silver, Black/Copper, White and with an opal or transparent diffuser.

IT Cipro è un apparecchio da parete dal design sfaccettato. Un classico senza tempo con alte performance in termini di resistenza.

Disponibile in cinque diverse finiture Nero, Nero/Verde, Nero/Argento, Nero/Rame, Bianco e con schermo opale o trasparente.

Cipro



Opal



transparent

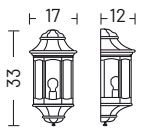

half wall lamp

MATERIALS





Body	Die-Cast aluminium EN47100
Diffuser	Polycarbonate
Finishing	Polyester powder paint

ELECTRIFICATION

Bulb	Base type	Max wattage	Bulb dimension
	E27	LED 25 W	Ø 6 x 15cm

ORDER CODE

WALL LAMP

420	Finishing	G	Black	
		P	Black/Green	
		R	Black/Silver	
		S	Black/Copper	
		U	White	
Diffuser			transparent	
	B		Opal	
Example			420 B G	



Firenze

design by Landa R&D

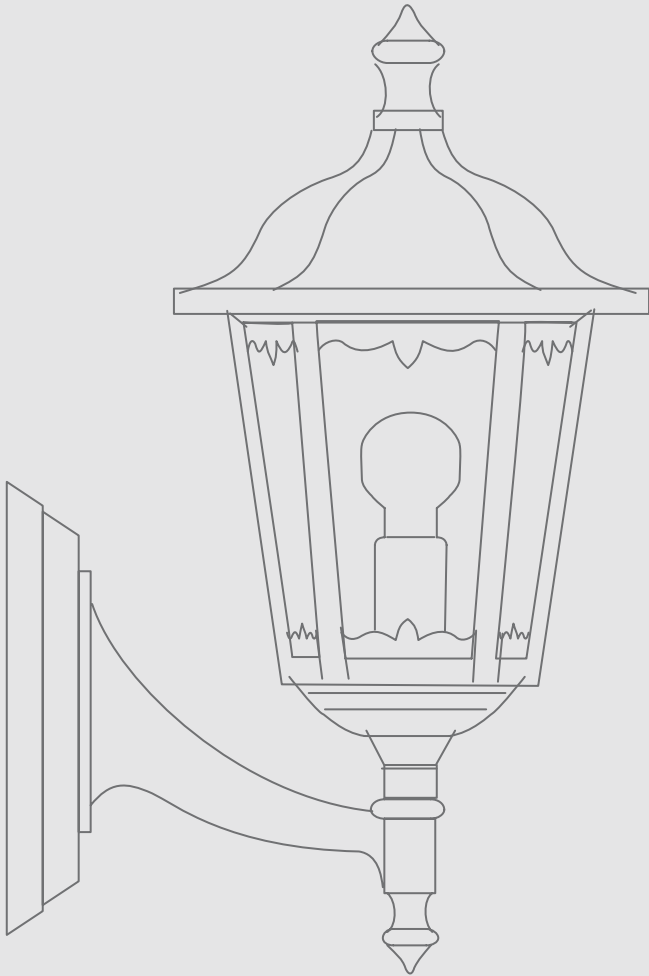

WALL LAMP

PENDANT

BOLLARD

POLE

EN Firenze is a series of lighting fixtures that evokes the timeless elegance of the Renaissance city from which it takes its name. This line is distinguished by its refinement and attention to detail, with EN47100 die-cast aluminium elements with the option of an aluminium or copper cap that reflect the artistic and architectural nuances of the Tuscan city. The versatility of Firenze is reflected in its many configurations: wall sconce, suspension, pole, and bollard, each designed to create a welcoming and refined atmosphere.

IT Firenze è una serie di apparecchi illuminanti che evoca l'eleganza senza tempo della città rinascimentale da cui prende il nome. Questa linea si distingue per la sua raffinatezza e attenzione ai dettagli, con elementi in alluminio pressofuso EN47100 con possibilità di avere il cappello in alluminio o in rame che riflettono le sfumature artistiche e architettoniche della città toscana. La versatilità di Firenze si manifesta nelle sue molteplici configurazioni: applique da parete, sospensione, pali e bollard, ognuno progettato per creare un'atmosfera accogliente e raffinata.

Firenze



aluminium top



copper top



upwards wall lamp
cod. 00

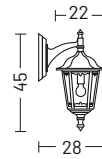

downwards wall lamp
cod. 01

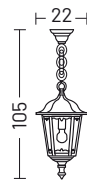

pendant
cod. 02



bollard
cod. 33



bollard
cod. 44

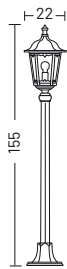

pole
cod. PF4

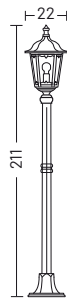

pole
cod. PF5

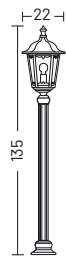

pole
cod. PR4

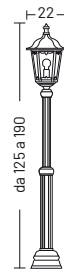

pole
cod. PR5







pole
cod. PR6

MATERIALS

Body	Die-cast aluminium EN47100
Diffuser	Glass
Finishing	Polyester powder paint

ORDER CODE

WALL LAMP | PENDANT | BOLLARD | POLE

330 ---	<i>Finishing</i>	G	Black		
		P	Black/Green		
		R	Black/Silver		
		S	Black/Copper		
		U	White		
	<i>Installation</i>	00	Upwards wall lamp		
		01	Downwards wall lamp		
		02	Pendant		
		33	Bollard h. 53 cm		
		44	Bollard h. 116 cm		
		PF4	pole 1L h. 155 cm *		
		PF5	pole 1L h 211 cm *		
	<i>Variant</i>	PR4	pole 1L h. 135 cm *		
		PR5	adjustable h. 125-190 cm *		
		PR6	adjustable h. 144-228 cm *		
	<i>Variant</i>	.	Aluminium top		
		A	Copper top		
	<i>Example</i>	330 A 01 G			

ELECTRIFICATION

Bulb	Base type	Max wattage	Bulb dimension
	E27	25 W	Ø 6 x 15cm

AVAILABLE ACCESSORIES

Code	Description	Page
00APF6	Anchor bolt for poles PF4/PF5/PF6	177
00APR6	Anchor bolt for poles PR5/PR6	177
00108G	Corner bracket	176
0404M003	Loop in loop out IP68	176
0404M004	Single connection IP68	176



* post and head complete height

Firenze

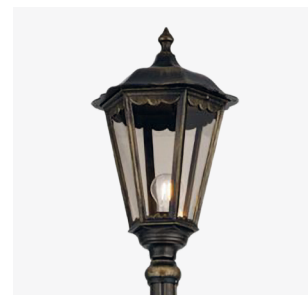

aluminium top



1 light head

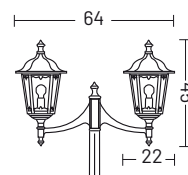

2 lights head
cod. T2

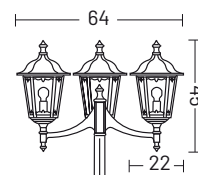

3 lights head
cod. T3

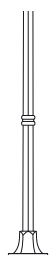

Pole cod.
PF6



Pole
cod. PF7

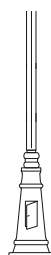

Pole
cod. PE7



Pole cod.
PF8



Pole cod.
PE8

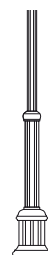

Pole cod.
PR7







Pole cod.
PR8

MATERIALS





Body	Die-cast aluminium EN47100
Diffuser	Glass
Finishing	Polyester powder paint

ORDER CODE

POLE 1 LIGHT

330 ---	Finishing	G	Black		
		P	Black/Green		
		R	Black/Silver		
		S	Black/Copper		
		U	White		
	Pole style	PF6	pole 1L h. 249 cm *		
		PF7	pole 1L h. 191 cm *		
		PF8	pole 1L h. 249 cm *		
		PE7	pole 1L h. 191 cm *		
		PE8	pole 1L h. 249 cm *		
PR7		adjustable h. 150-215 cm *			
Variant	PR8	adjustable h. 180-245 cm *			
	.	Aluminium top			
Example		330.PF8 G			

POLE 2 OR 3 LIGHT

330 ---	Finishing	G	Black		
		P	Black/Green		
		R	Black/Silver		
		S	Black/Copper		
		U	White		
	Lights	T2	2 lights		
		T3	3 lights		
	Pole style	PF8	pole h. 249 cm *		
		PE8	pole h. 249 cm *		
		PR8	adjustable h. 180-245 cm *		
Variant	.	Aluminium top			
	A	Copper top			
Example		330.PF8 T3 G			

ELECTRIFICATION

Bulb	Base type	Max wattage	Bulb dimension
	E27	25 W	Ø 6 x 15cm

AVAILABLE ACCESSORIES

Code	Description	Page
00APF8	Anchor bolt for poles PF7/PF8/PE7/PE8	177
00APR8	Anchor bolt for poles PR7/PR8	177
0404M003	Loop in loop out IP68	176
0404M004	Single connection IP68	176

* post and head complete height

Lampara

design by Landa R&D

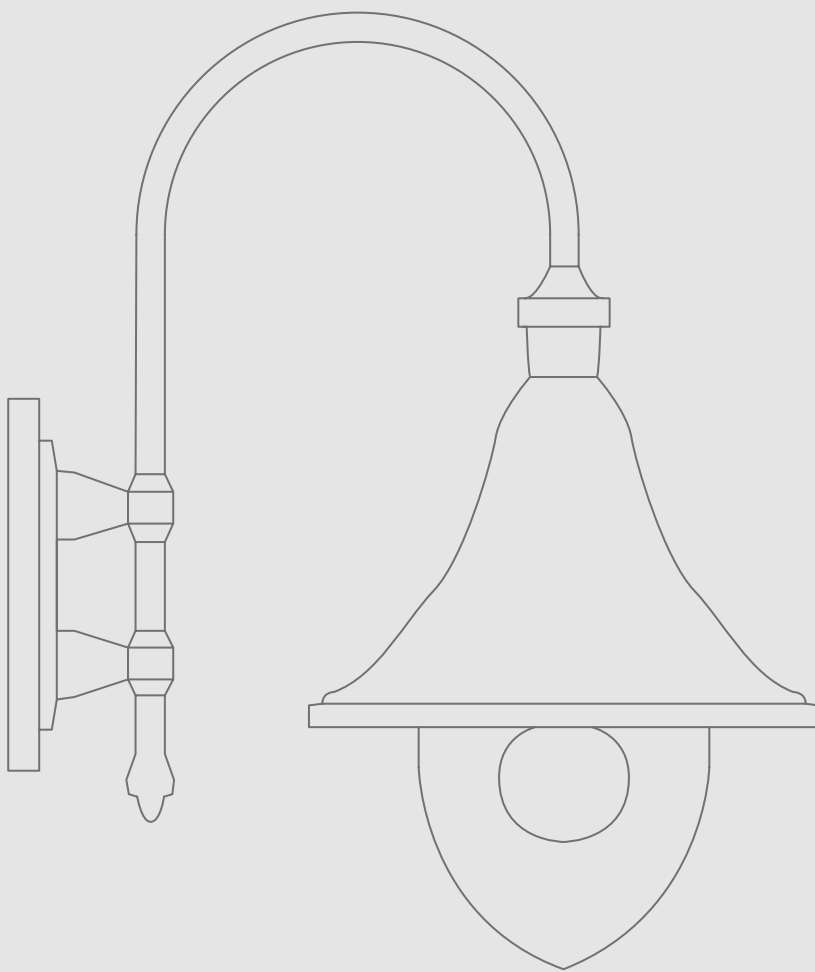

WALL LAMP

PENDANT

BOLLARD

POLE

EN A lighting system inspired by the traditional 'lampare' used by fishermen to attract fish during nights on the open sea. This collection combines the practicality of modern lighting with the rustic charm of maritime design, evoking the ancient fishing techniques of the Mediterranean. The EN47100 die-cast aluminium body is available in several finishes, including black, black/silver and with the option of a copper cap, reflecting the shimmer of the sea under the moon. Also available with an opal polycarbonate diffuser, it guarantees a soft and diffused light, ideal for creating a cosy and suggestive atmosphere in any outdoor environment. Available as wall sconce, suspension, bollard, and poles in various heights.

IT Sistema di illuminazione che trae ispirazione dalle tradizionali lampare usate dai pescatori per attrarre pesce durante le notti in mare aperto. Questa collezione combina la praticità dell'illuminazione moderna con il fascino rustico del design marinaro, rievocando le antiche tecniche di pesca del Mediterraneo. Il corpo in alluminio pressofuso EN47100 è disponibile in diverse finiture, tra cui nero, nero/argento e con possibilità di avere il cappello rame, che riflettono il luccichio del mare sotto la luna. Disponibile anche con il diffusore in polycarbonato opalino garantisce una luce morbida e diffusa, ideale per creare un'atmosfera accogliente e suggestiva in qualsiasi ambiente esterno. Disponibile come applique da parete, sospensione, bollard e pali di varie altezze.

Lampara_1



aluminium top

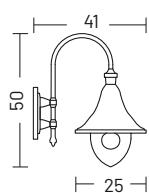
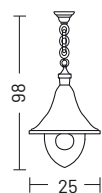
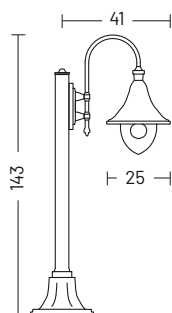
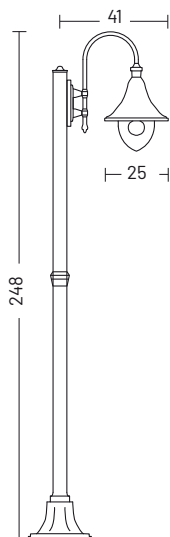
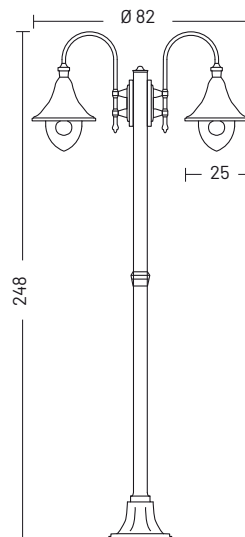
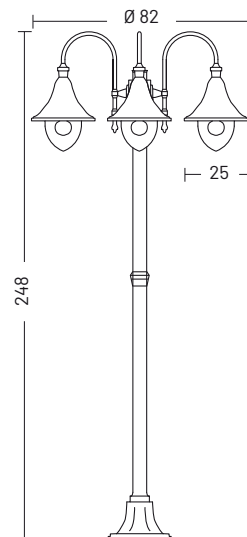

copper top

downwards wall lamp
cod. 01pendant
cod. 02bollard
cod. P1.12Pole | 1 light
cod. P1Pole | 2 lights
cod. P2Pole | 3 lights
cod. P3

MATERIALS





Body	Die-cast aluminium EN47100
Diffuser	Transparent polycarbonate
Finishing	Polyester powder paint

ELECTRIFICATION

Bulb	Base type	Max wattage	Bulb dimension
	E27	LED 25 W	Ø 6 x 15cm

ORDER CODE

WALL LAMP | PENDANT | BOLLARD | POLE

100	<i>Finishing</i>	G	Black	
		P	Black/Green	
		R	Black/Silver	
		S	Black/Copper	
		U	White	
	<i>Installation</i>	01	Downwards wall lamp	
		02	Pendant	
		P1.12	Bollard	
		P1	pole 1L	
		P2	pole 2L	
	<i>Variant</i>	.	Aluminium top	
		A	Copper top	

Example **100 A 01 G**

AVAILABLE ACCESSORIES

Code	Description	Page
00APL6	Anchor bolt	177
00108G	Corner bracket	176
0404M003	Loop in loop out IP68	176
0404M004	Single connection IP68	176

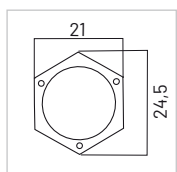

base dimensions



Lampara_2

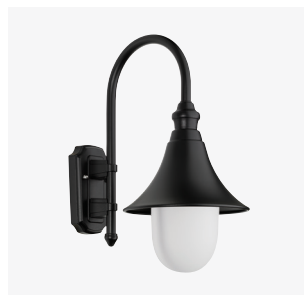

aluminium top

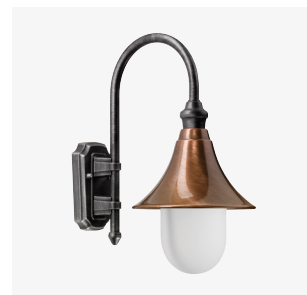

copper top

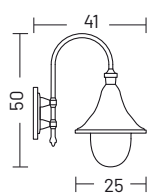

downwards wall lamp
cod. 01

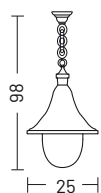

pendant
cod. 02

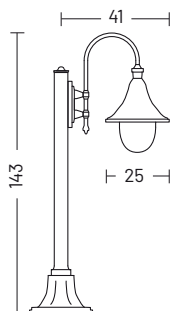

bollard
cod. P1.12

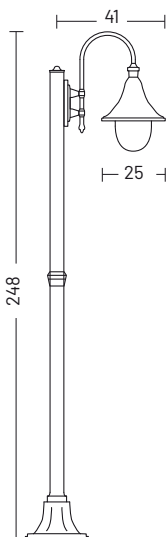

Pole | 1 light
cod. P1

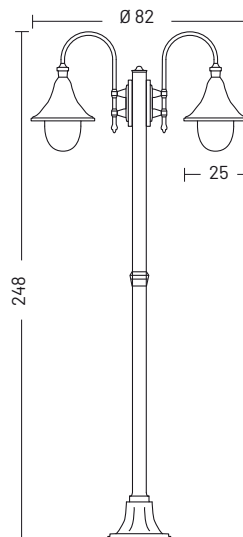

Pole | 2 lights
cod. P2

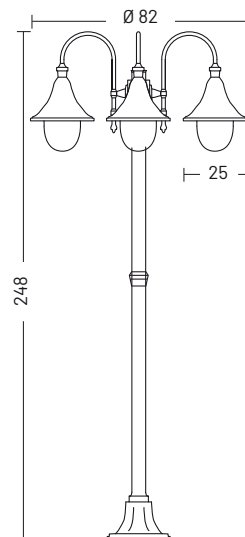





Pole | 3 lights
cod. P3

MATERIALS

Body	Die-cast aluminium EN47100
Diffuser	Opal polycarbonate
Finishing	Polyester powder paint

ORDER CODE

WALL LAMP | PENDANT | BOLLARD | POLE

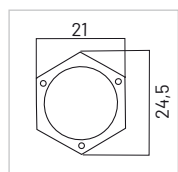

100	Finishing	G	Black	
		P	Black/Green	
		R	Black/Silver	
		S	Black/Copper	
		U	White	
	Source lamp	B	E27	
		LHB	LED	
	Installation	01	Downwards wall lamp	
		02	Pendant	
		P1.12	Bollard	
		P1	pole 1L	
		P2	pole 2L	
		P3	pole 3L	
	Variant	.	Aluminium top	
		A	Copper top	

Example **100 A 01 B G**



base dimensions

ELECTRIFICATION

Bulb	Base type	Max wattage	Bulb dimension
	E27	LED 25 W	Ø 6 x 15cm
	-	LED 12 W	3000 K 1100 lm Ra80

AVAILABLE ACCESSORIES

Code	Description	Page
00APL6	Anchor bolt	177
00108G	Corner bracket	176
0404M003	Loop in loop out IP68	176
0404M004	Single connection IP68	176



Lyras 80.1

design by Landa R&D

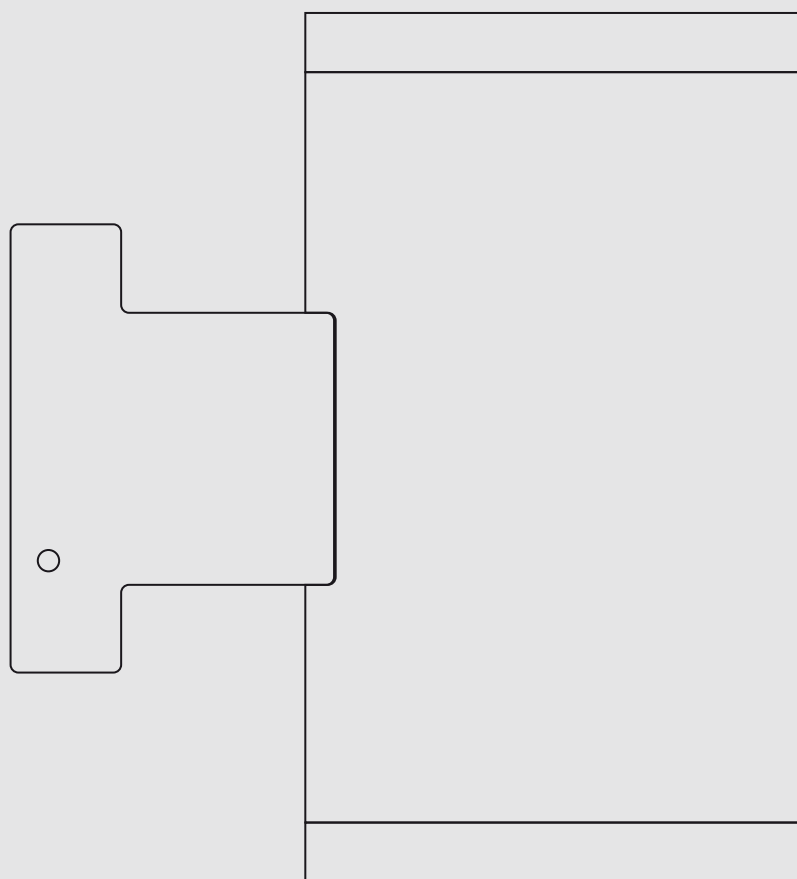

WALL LAMP

EN Lyras 80.1 is available with single or dual emission optics. A luminaire with an EN47100 die-cast aluminium structure, with excellent resistance to oxidation achieved through specific treatments. The mechanical couplings are protected with EPDM 70SH gaskets for a perfect seal.

The optimisations carried out on the component couplings, in fact, make it possible to achieve excellent resistance, as well as high light emission accentuated by the transparency of the mechanical couplings.

IT Lyras 80.1 è disponibile con ottica ad emissione singola o doppia. Un apparecchio dalla struttura in alluminio pressofuso EN47100, con ottima resistenza all'ossidazione ottenuta con specifici trattamenti. Gli accoppiamenti meccanici sono protetti con guarnizioni in EPDM 70SH, per una tenuta perfetta.

Le elevate prestazioni di Lyras 80.1 sono l'ideale per applicazioni in ambienti esterni. Le ottimizzazioni effettuate sugli accoppiamenti dei componenti, infatti, permettono di raggiungere un'ottima resistenza, oltre ad un'alta emissione luminosa accentuata dal vetro trasparente.

Lyras 80.1

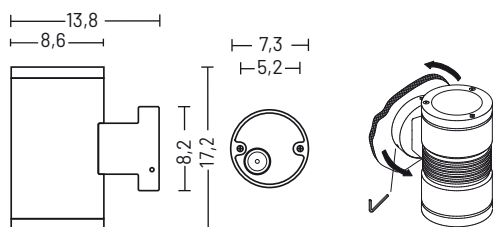

easy installation



cod. X1





cod. X2

MATERIALS



Body	Die-Cast aluminium EN47100
Diffuser	Glass transparent
Finishing	Polyester powder paint

ELECTRIFICATION

Bulb	Base type	Voltage	Max wattage	Bulb dimension
	GU10	12 V	LED 6 W	Ø 5,1 x 6,2cm
	GU10	12 V	LED 9 W	Ø 4,8 x 6,8cm
	GU5.3	12 V	LED 8 W	Ø 5,1 x 6,2cm

ORDER CODE

WALL LAMP

4652 ---	Finishing	H	Grey	
		L	Graphite	
	Emission	X1	Mono	
		X2	Double	
	Bulb	GU10	LED GU10*	
		GU5.3	LED GU5.3*	
	Example	4652GU10X1L		



*Bulbs not included. Bulbs suggested: LED Megaman, LED Osram Parathom

Maiorca

design by Landa R&D

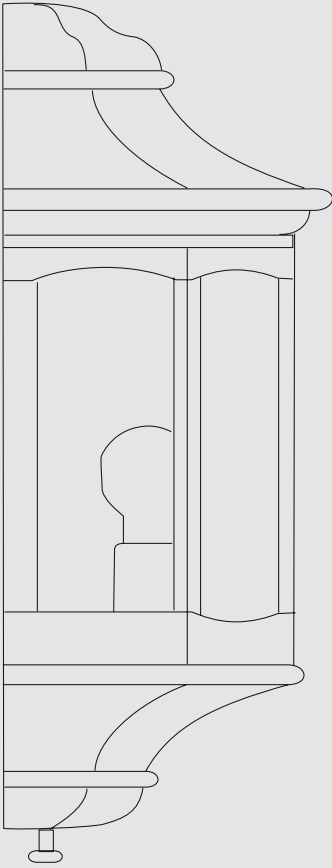

WALL LAMP

EN Maiorca is a luminaire that captures the elegance of the Spanish island by reflecting its tranquillity through elegant design and long-lasting materials. This outdoor product combines a robust EN47100 die-cast aluminium body with opal or transparent diffusers that diffuse a welcoming light. Available in various finishes including black, black/green, black/silver, black/copper and classic white, Maiorca is perfect for adding a touch of class to gardens, pathways, and facades, adding a touch of Mediterranean flair.

IT Maiorca è un apparecchio d'illuminazione che cattura l'eleganza dell'isola spagnola riflettendone la tranquillità, attraverso un design elegante e materiali long lasting. Questo prodotto per esterni combina un corpo robusto in alluminio pressofuso EN47100 con diffusori in opale o trasparente che diffondono una luce accogliente. Disponibile in diverse finiture come nero, nero/verde, nero/argento, nero/rame e nel classico bianco, Maiorca è perfetta per aggiungere un tocco di classe a giardini, vialetti e facciate, portando con sé un tocco di aria mediterranea.

Maiorca



opal



transparent

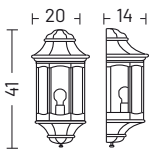

half wall lamp

MATERIALS

Body	Die-Cast aluminium EN47100
Diffuser	Polycarbonate
Finishing	Polyester powder paint







ELECTRIFICATION

Bulb	Base type	Max wattage	Bulb dimension
	E27	LED 25 W	Ø 6 x 15cm

ORDER CODE

WALL LAMP

421 _ _

Finishing	G	Black	
	P	Black/Green	
	R	Black/Silver	
	S	Black/Copper	
	U	White	
Diffuser		Transparent	
	B	Opal	
	BSEN	Opal with Sensor	

Example 421 **G**

Example 421 **SEN P** (Optional Sensor)



Monaco

design by Landa R&D

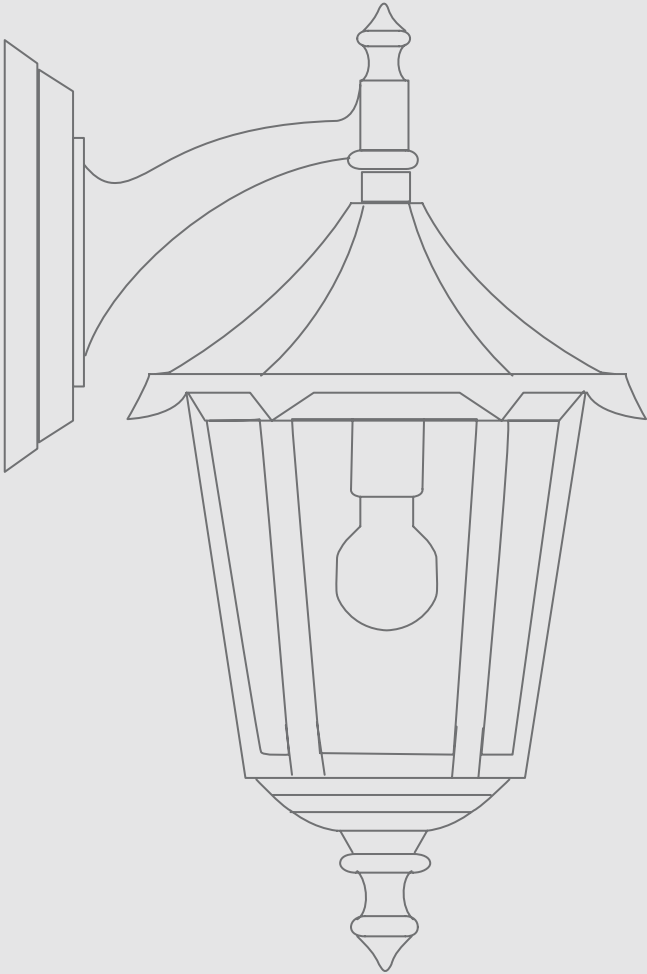

WALL LAMP

PENDANT

BOLLARD

POLE

EN Munich in Bavaria, with its unique blend of Bavarian tradition and modernity, inspires the Monaco lighting range, which combines classic design with impeccable functionality.

Multiple finishes combined with aluminium or copper caps are reflected in the carefully crafted details of each lantern, evoking the elegance and robustness of the city's architecture. This series offers versatility with various installation options: wall sconce, suspension, pole, and bollard, ideal for outdoor environments that require a touch of timeless style.

IT Monaco di Baviera, con il suo mix unico di tradizione bavarese e modernità, ispira la gamma di illuminazione Monaco, che combina design classico con una funzionalità impeccabile. Molteplici sono le finiture abbinare con cappello in alluminio o rame che si riflettono nei dettagli accuratamente lavorati di ciascuna lanterna, evocando l'eleganza e la robustezza delle architetture della città. Questa serie offre versatilità con varie opzioni di installazione: applique da parete, sospensione, pali e bollard, ideali per ambienti esterni che richiedono un tocco di stile senza tempo.

Monaco

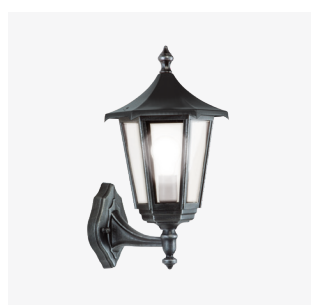

aluminium top



copper top



upwards wall lamp
cod. 00



downwards wall lamp
cod. 01



pendant
cod. 02



bollard
cod. 33

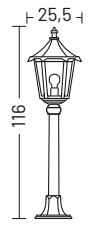

bollard
cod. 44

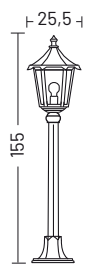

pole
cod. PF4

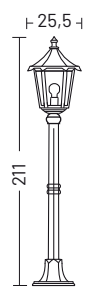

pole
cod. PF5

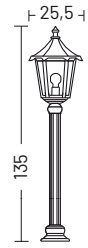

pole
cod. PR4

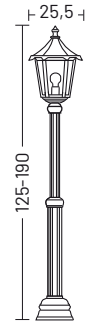





pole
cod. PR5

MATERIALS

Body	Die-cast aluminium EN47100
Diffuser	Glass
Finishing	Polyester powder paint

ORDER CODE

WALL LAMP | PENDANT | BOLLARD | POLE

340 ---	<i>Finishing</i>	G	Black		
		P	Black/Green		
		R	Black/Silver		
		S	Black/Copper		
		U	White		
	<i>Installation</i>	00	Upwards wall lamp		
		01	Downwards wall lamp		
		02	Pendant		
		33	Bollard h. 53 cm		
		44	Bollard h. 116 cm		
		PF4	pole 1L h. 155 cm *		
	<i>Variant</i>	PF5	pole 1L h. 211 cm *		
		PR4	pole 1L h. 135 cm *		
		PR5	adjustable h. 125-190 cm *		
		.	Aluminium top		
		A	Copper top		
	<i>Example</i>	340 A 01 G			

ELECTRIFICATION

Bulb	Base type	Max wattage	Bulb dimension
	E27	LED 25 W	Ø 6 x 15cm

AVAILABLE ACCESSORIES

Code	Description	Page
00APF6	Anchor bolt for poles PF4/PF5	177
00APR6	Anchor bolt for poles PR5	177
00108G	Corner bracket	176
0404M003	Loop in loop out IP68	176
0404M004	Single connection IP68	176



* post and head complete height

Monaco



aluminium top



copper top

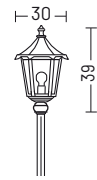

1 light head

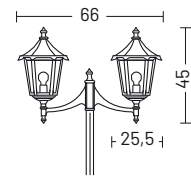

2 lights head
cod. T2

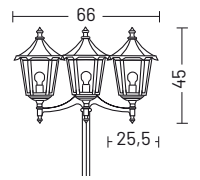

3 lights head
cod. T3

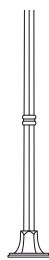

Pole cod.
PF6



Pole
cod. PF7



Pole
cod. PE7

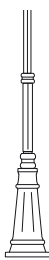

Pole cod.
PF8



Pole cod.
PE8

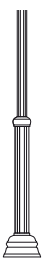

Pole cod.
PR6

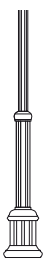

Pole cod.
PR7







Pole cod.
PR8

MATERIALS





Body	Die-Cast aluminium EN47100
Diffuser	Glass
Finishing	Polyester powder paint

ORDER CODE

POLE 1 LIGHT

340 _ _ _	Finishing	G	Black		
		P	Black/Green		
		R	Black/Silver		
		S	Black/Copper		
		U	White		
	Pole style	PF6	pole 1L h. 249 cm *		
		PF7	pole 1L h. 191 cm *		
		PF8	pole 1L h. 249 cm *		
		PE7	pole 1L h. 191 cm *		
		PE8	pole 1L h. 249 cm *		
		PR6	adjustable h. 145-229 cm *		
		PR7	adjustable h. 150-215 cm *		
PR8		adjustable h. 180-245 cm *			
Variant	.	Aluminium top			
	A	Copper Top			
Example	340 . PF8 G				

POLE 2 OR 3 LIGHT

340 _ _ _	Finishing	G	Black		
		P	Black/Green		
		R	Black/Silver		
		S	Black/Copper		
		U	White		
	Lights	T2	2 lights		
		T3	3 lights		
	Pole style	PF6	pole h. 255 cm *		
		PF8	pole h. 255 cm *		
		PE8	pole h. 255 cm *		
		PR6	adjustable h. 150-234 cm *		
	Variant	.	Aluminium top		
A		Copper Top			
Example	340 . PF8 T2 G				

ELECTRIFICATION

Bulb	Base type	Max wattage	Bulb dimension
	E27	LED 25 W	Ø 6 x 15cm

AVAILABLE ACCESSORIES

Code	Description	Page
00APF6	Anchor bolt for poles PF6	177
00APF8	Anchor bolt for poles PF7/PF8/PE7/PE8	177
00APR6	Anchor bolt for poles PR6	177
00APR8	Anchor bolt for poles PR7/PR8	177
0404M003	Loop in loop out IP68	176
0404M004	Single connection IP68	176

* post and head complete height

Morphis

design by Landa R&D

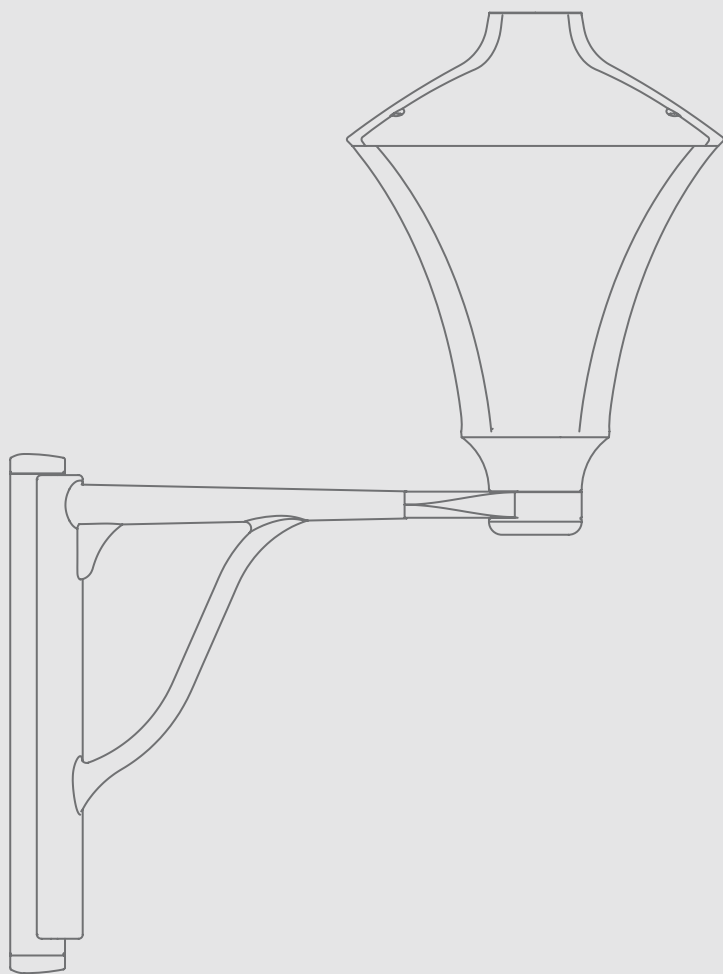

HEAD POST | WALL LAMP | PENDANT | BOLLARD | POLE

EN The shape of old lanterns, typical of the outdoor lighting tradition for Morphis: the classic transported into the contemporary. Diffused light and an extra-clear polycarbonate diffuser. A luminaire for illuminating driveways and outdoor paths, available for wall, suspension, bollard, and aluminium pole applications in different heights and 6 colour variants.

IT La forma delle vecchie lanterne, tipiche della tradizione illuminotecnica da esterni per Morphis: il classico trasportato nella contemporaneità. Una luce diffusa e uno schermo extra chiaro in polycarbonato. Un apparecchio per illuminare strade di accesso e vialetti esterni, disponibile per applicazioni a muro, sospensione, bollard e con palo in alluminio di differenti altezze e disponibile in 6 varianti colore.

Morphis_1

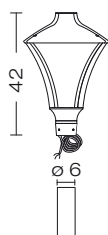

head post
cod. TSE27



bollard
cod. 33

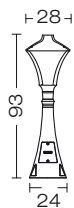

bollard
cod. 095



pole 1L
cod. 180

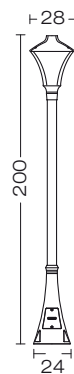

pole 1L
cod. 200

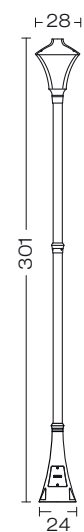







pole 1L
cod. 300

MATERIALS

Body	Die-cast aluminium EN47100
Diffuser	Transparent polycarbonate
Finishing	Polyester powder paint

ORDER CODE

BOLLARD | POLE | HEAD POST

177	Finishing	G	Black	
		L	Graphite	
		P	Black/Green	
		R	Black/Silver	
		S	Black/Copper	
		V	Oxide	
Installation	TSE27	Head post		
	33	bollard h. 54 cm		
	095	bollard h. 93 cm		
	180	pole 1L h. 178 cm.		
	200	pole 1L h. 200 cm.		
	300	pole 1L h. 301 cm.		
Diffuser	.	Transparent		

Example **177 . 33 G**

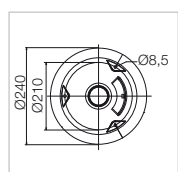

base dimensions

ELECTRIFICATION

Bulb	Base type	Max wattage	Bulb dimension
	E27	LED 25 W	Ø 6 x 15cm

INCLUDED ACCESSORIES

Code	Description	Page
0404M004	Single connection IP68	176

AVAILABLE ACCESSORIES

Code	Description	Page
00A170.01P	Anchor bolt (not available for 177.33)	177
0404M003	Loop in loop out connection IP68	176
00KR175U	Refractor	176

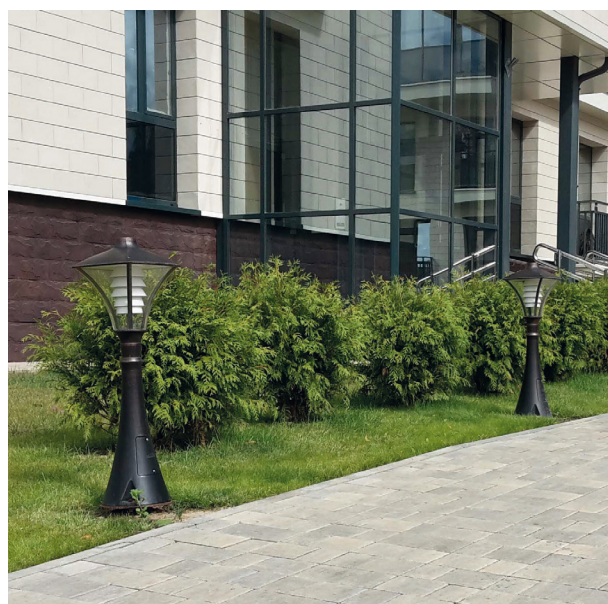

Morphis_2

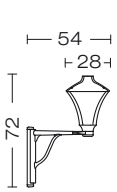

upwards wall lamp
cod. 00



pendant
cod. 02

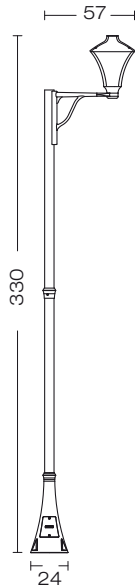

pole 1L
cod. P1

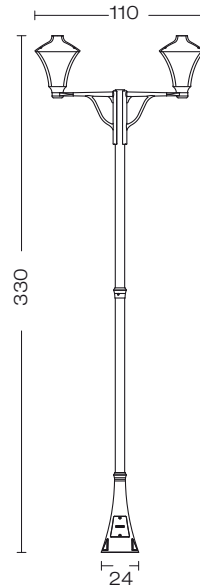

pole 2L
cod. P2

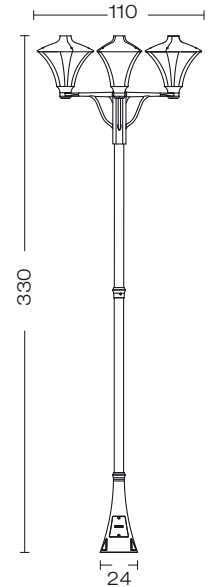







pole 3L
cod. P3

MATERIALS







Body	Die-cast aluminium EN47100
Diffuser	Transparent polycarbonate
Finishing	Polyester powder paint

ORDER CODE

WALL LAMP | POLE

175	Finishing	G	Black	
		L	Graphite	
		P	Black/Green	
		R	Black/Silver	
		S	Black/Copper	
		V	Oxide	
	Installation	00	Upwards wall lamp	
	P1	pole 1L		
	P2	pole 2L		
	P3	pole 3L		
	Diffuser	.	Transparent	
	Example	175 . P1G		

PENDANT

176.02	Finishing	G	Black	
		L	Graphite	
		P	Black/Green	
		R	Black/Silver	
		S	Black/Copper	
		V	Oxide	
	Example	176.02 G		

ELECTRIFICATION

Bulb	Base type	Max wattage	Bulb dimension
	E27	LED 25 W	Ø 6 x 15cm

INCLUDED ACCESSORIES

Code	Description	Page
0404M004	Single connection IP68	176

AVAILABLE ACCESSORIES

Code	Description	Page
00A170.01P	Anchor bolt	177
00596_	Corner bracket (available in different colours, see accessories section)	176
0404M003	Loop in loop out connection IP68	176
00KR175U	Refractor	176

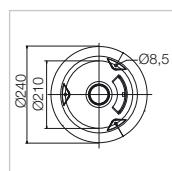

base dimensions



Morphis_3

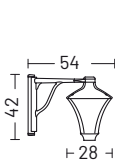

downwards wall lamp
cod. 01



pendant
cod. 02

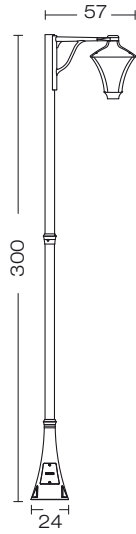

pole 1L
cod. P1

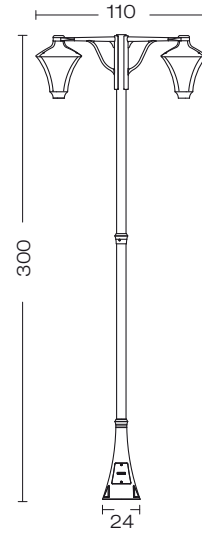

pole 2L
cod. P2

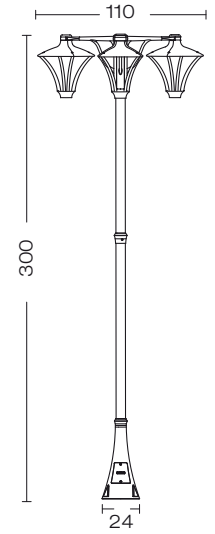







pole 3L
cod. P3

MATERIALS

Body	Die-cast aluminium EN47100
Diffuser	Transparent polycarbonate
Finishing	Polyester powder paint

ORDER CODE

WALL LAMP | PENDANT | POLE

176	<i>Finishing</i>	G	Black	
		L	Graphite	
		P	Black/Green	
		R	Black/Silver	
		S	Black/Copper	
		V	Oxide	
	<i>Installation</i>	01	Downwards wall lamp	
		02	Pendant	
		P1	pole 1L	
		P2	pole 2L	
	<i>Diffuser</i>	P3	pole 3L	
		.	Transparent	
<i>Example</i>	176 . P1G			

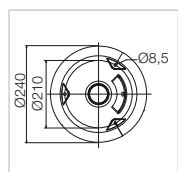

base dimensions

ELECTRIFICATION

Bulb	Base type	Max wattage	Bulb dimension
	E27	LED 25 W	Ø 6 x 15cm

INCLUDED ACCESSORIES

Code	Description	Page
0404M004	Single connection IP68	176

AVAILABLE ACCESSORIES

Code	Description	Page
00A170.01P	Anchor bolt	177
00596_	Corner bracket (available in different colours, see accessories section)	176
0404M003	Loop in loop out connection IP68	176
00KR175U	Refractor	176



Morphis Wall_1

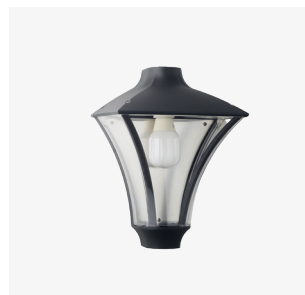

transparent



Opal

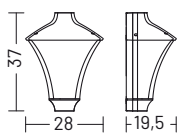

half wall lamp

MATERIALS

Body	Die-cast aluminium EN47100
Diffuser	Polycarbonate
Finishing	Polyester powder paint







ELECTRIFICATION

Bulb	Base type	Max wattage	Bulb dimension
	E27	LED 25 W	Ø 6 x 15cm

ORDER CODE

WALL LAMP

175 _ _

<i>Finishing</i>	G	Black	
	L	Graphite	
	P	Black/Green	
	R	Black/Silver	
	S	Black/Copper	
	V	Oxide	
<i>Diffuser</i>		Transparent	
	B	Opal	
	BSEN	Opal with Sensor	

Example 175 **G**

Example 175 **SEN P** (Optional Sensor)



Neway

design by Landa R&D



WALL LAMP



BOLLARD

EN Neway's evocative and elegant shape is available for wall and bollard application. Bollards in heights of 45, 75, 100 and 125 cm, three possible finishes, Graphite, Grey, and Oxide, with a transparent polycarbonate diffuser. Transparent or opal diffuser available for the wall version. Neway stands for absolute three-dimensionality, solidity, and perfect light distribution.

IT Una forma evocativa ed elegante quella di Neway, disponibile per applicazione a parete e bollard. Bollard con altezze da 45, 75, 100 e 125 cm, tre possibili finiture, Grafite, Grigio e Ossido, con diffusore trasparente in polycarbonato. Diffusore trasparente o opale disponibile per la versione a parete. Neway è tridimensionalità assoluta, solidità e perfetta distribuzione luminosa.

Neway



opal



transparent

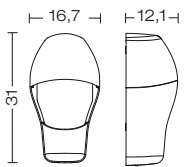

half wall lamp

MATERIALS

Body	Die-cast aluminium EN47100
Diffuser	Polycarbonate
Finishing	Polyester powder paint



ELECTRIFICATION

Bulb	Base type	Max wattage	Bulb dimension
	E27	25 W	Ø 6 x 15cm

ORDER CODE

WALL LAMP

405 _ _

Finishing	H	Grey	
	L	Graphite	
	V	Oxide	
Diffuser		Transparent	
	B	Opal	

Example 405 B H



Neway

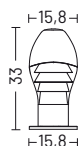

*bollard
cod. 03*

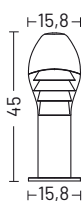

*bollard
cod. 045*

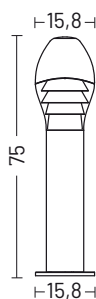

*bollard
cod. 075*

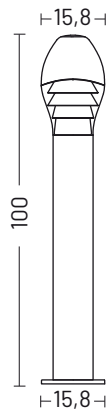

*bollard
cod. 100*





*bollard
cod. 125*

MATERIALS

Body	Die-cast aluminium EN47100 and extruded aluminium AW6060
Diffuser	Transparent polycarbonate
Finishing	Polyester powder paint

ORDER CODE

WALL LAMP | PENDANT | BOLLARD

405	Finishing	H	Grey	
		L	Graphite	
		V	Oxide	
	Installation	03	Bollard h. 33 cm	
		045	Bollard h. 45 cm	
		075	Bollard h. 75 cm	
		100	Bollard h. 100 cm	
		125	Bollard h. 125 cm	
	Diffuser	.	Transparent	
	Example	405 . 100 L		

ELECTRIFICATION

Bulb	Base type	Max wattage	Bulb dimension
	E27	25 W	Ø 6 x 15cm

INCLUDED ACCESSORIES

Code	Description	Page
0404M004	Single connection IP68	176

AVAILABLE ACCESSORIES

Code	Description	Page
00A405.01P	Anchor bolt	177
0404M003	Loop in loop out IP68	176
00A405	Root Mounting Kit h. 47 cm	177



Nizza

design by Landa R&D

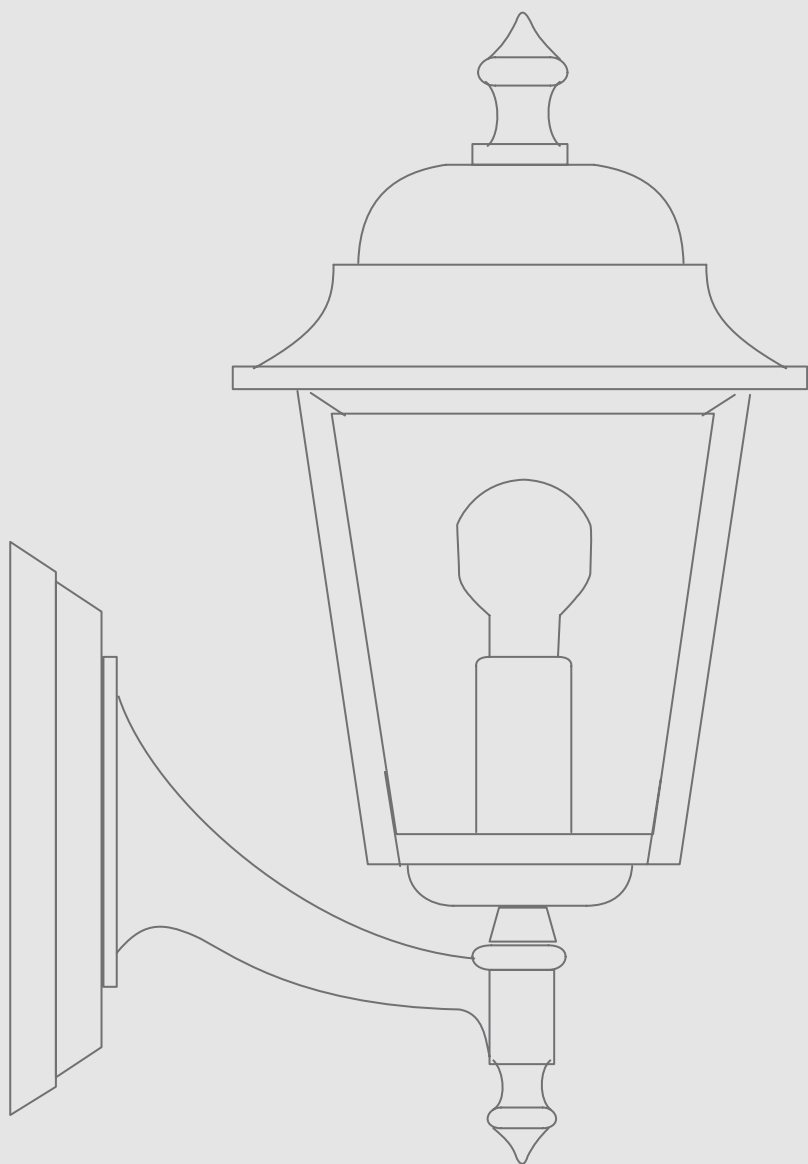

WALL LAMP

PENDANT

BOLLARD

POLE

EN Nizza, inspired by the lively atmosphere and elegance of the famous Côte d'Azur city, reflects a harmony of style and functionality. This lighting series combines a classic structure with an aged copper finish that recalls the charm of old European maritime cities. With mounting options that include wall sconces, suspension lamps, bollards, and poles of various heights, Nizza is perfect for any outdoor space, from private gardens to city streets, offering a warm and welcoming light. The series is versatile and durable, designed to withstand the elements and illuminate spaces with a touch of timeless elegance.

IT Nizza, ispirata alla vivace atmosfera e all'eleganza della celebre città della Costa Azzurra, riflette un'armonia di stile e funzionalità. Questa serie di apparecchi illuminanti combina una struttura classica con una finitura in rame invecchiato che richiama il fascino delle vecchie città marittime europee. Con opzioni di montaggio che includono applique da parete, lampade a sospensione, bollard e pali di varie altezze, Nizza è perfetta per ogni spazio esterno, da giardini privati a vie cittadine, offrendo una luce calda e accogliente. La serie è versatile e duratura, progettata per resistere agli elementi e illuminare gli spazi con un tocco di raffinatezza senza tempo.

Nizza_1

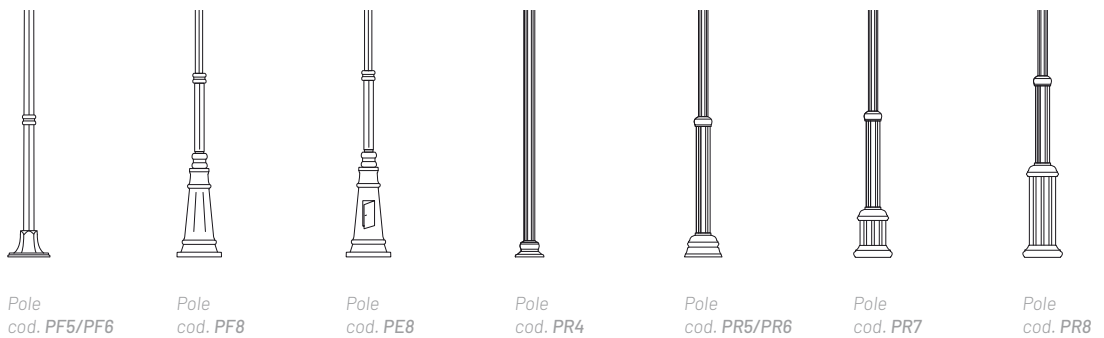
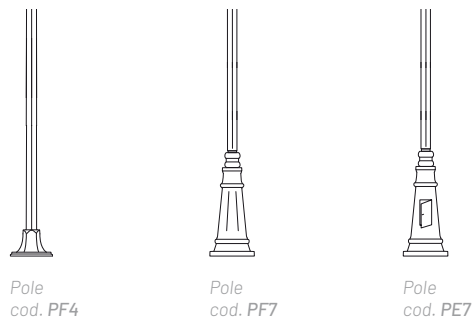
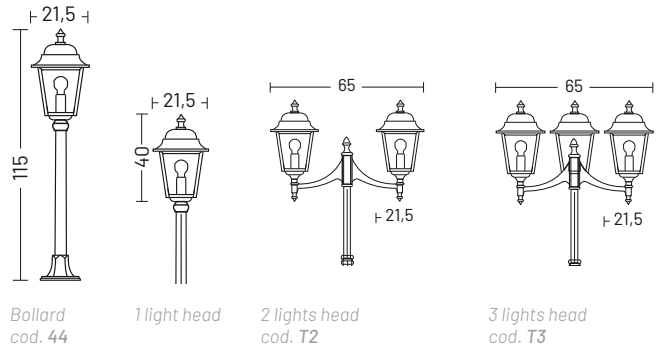
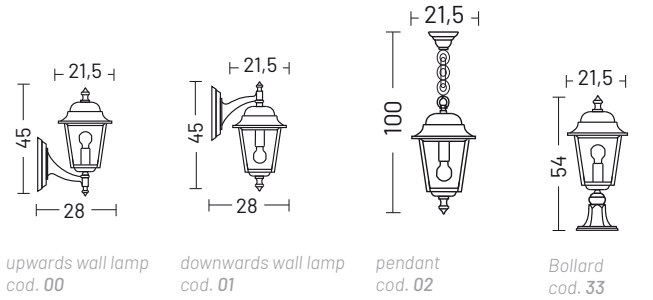





MATERIALS





Body	Die-Cast aluminium EN47100
Diffuser	Glass
Finishing	Polyester powder paint

ORDER CODE





WALL LAMP | BOLLARD | PENDANT

391 ---	Finishing	G	Black	
		P	Black/Green	
		S	Black/Copper	
		U	White	
		Installation	00	Upwards wall lamp
		01	Downwards wall lamp	
		02	Pendant	
		33	Bollard h. 54 cm	
		44	Bollard h. 115 cm	
	Diffuser	.	Transparent	
	Example	391 . 00 G		

POLE 1 LIGHT

391 ---	Finishing	G	Black		
		P	Black/Green		
		S	Black/Copper		
		U	White		
		Pole style	PF4	pole 1L h. 156 cm *	
	PF5		pole 1L h. 212 cm *		
	PF6		pole 1L h. 250 cm *		
	PF7		pole 1L h. 192 cm *		
	PF8		pole 1L h. 250 cm *		
	PE7		pole 1L h. 192 cm *		
	PE8		pole 1L h. 250 cm *		
	PR4		pole 1L h. 136 cm *		
	PR5		adjustable h. 126/191 cm *		
			adjustable h. 145/229 cm *		
	PR6		adjustable h. 151/216 cm *		
	Diffuser		.	Transparent	
	Example		391 . PF5 G		

POLE 2 OR 3 LIGHTS

391 ---	Finishing	G	Black	
		P	Black/Green	
		S	Black/Copper	
		U	White	
		Lights	T2	2 lights
	T3		3 lights	
	Pole style		PF8	pole h. 255 cm *
		PE8	pole h. 255 cm *	
		PR8	adjustable h. 186/251 cm *	
	Diffuser	.	Transparent	
	Example	391 . PF8 T2 G		

ELECTRIFICATION

Bulb	Base type	Max wattage	Bulb dimension
	E27	25 W	Ø 6 x 12cm

AVAILABLE ACCESSORIES

Code	Description	Page
00APF6	Anchor bolt for poles PF4/PF5/PF6	177
00APF8	Anchor bolt for poles PF7/PF8/PE7/PE8	177
00APR6	Anchor bolt for poles PR5/PR6	177
00APR8	Anchor bolt for poles PR7/PR8	177
00108G	Corner bracket	176
0404M003	Loop in loop out IP68	176
0404M004	Single connection IP68	176

* post and head complete height

Nizza_2

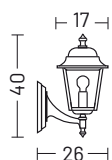

upwards wall lamp
cod. 00

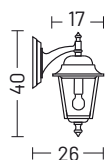

downwards wall lamp
cod. 01

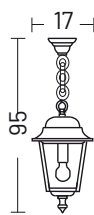

pendant
cod. 02



Bollard
cod. 33

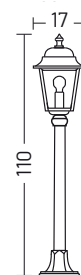

Bollard
cod. 44

MATERIALS

Body	Die-Cast aluminium EN47100
Diffuser	Glass
Finishing	Polyester powder paint





ELECTRIFICATION

Bulb	Base type	Max wattage	Bulb dimension
	E27	25 W	Ø 6 x 12cm

ORDER CODE

WALL LAMP | BOLLARD | PENDANT

390 _ _ _

<i>Finishing</i>	G	Black	
	P	Black/Green	
	S	Black/Copper	
	U	White	
<i>Installation</i>	00	Upwards wall lamp	
	01	Downwards wall lamp	
	02	Pendant	
	33	Bollard h. 49 cm	
	44	Bollard h. 110 cm	
<i>Diffuser</i>	.	Transparent	
<i>Example</i>	390 . 00 G		

AVAILABLE ACCESSORIES

Code	Description	Page
0404M004	Single connection IP68	176
0404M003	Loop in loop out IP68	176
00108G	Corner bracket	176

Orion

design by Landa R&D

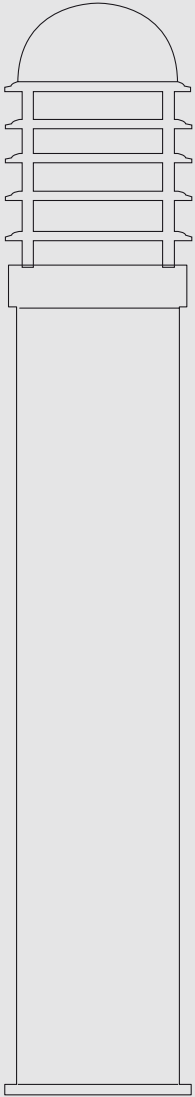

WALL LAMP



BOLLARD

EN The Orion series is designed with an emphasis on durability and modern aesthetics, making it an ideal choice for lighting outdoor spaces. Made of EN47100 die-cast aluminium, extruded AW6060 aluminium and AISI316L stainless steel, these bollards are not only robust and durable, but also strikingly elegant. The opal polycarbonate diffuser ensures a uniform spread of light, ideal for creating luminous pathways or accentuating the night landscape. Available in different heights and finishes including black, grey, graphite, white, and oxide, the Orion series bollards can transform any outdoor area.

IT La serie Orion è progettata con un'attenzione particolare alla durabilità e all'estetica moderna, rendendola una scelta ideale per l'illuminazione di spazi esterni. Realizzati in alluminio pressofuso EN47100, estruso AW6060 e acciaio inossidabile AISI316L, questi bollard sono non solo robusti e resistenti, ma anche sorprendentemente eleganti. Il diffusore in polycarbonato opalino garantisce una diffusione uniforme della luce, ideale per creare sentieri luminosi o per accentuare il paesaggio notturno. Disponibili in diverse altezze e finiture come il nero, grigio, grafite, bianco, e ossido, i bollard della serie Orion possono trasformare qualsiasi area outdoor.

Orion_1

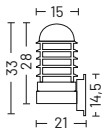

upwards wall lamp
cod. 00

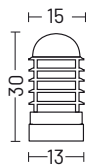

bollard
cod. 03

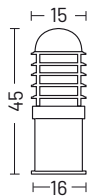

bollard
cod. 045

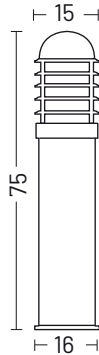

bollard
cod. 075

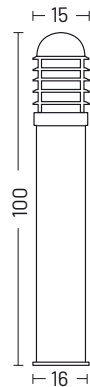

bollard
cod. 100



bollard
cod. 125





MATERIALS

Body	Die-cast aluminium EN47100 and extruded aluminium AW6060
Diffuser	Polycarbonate opal
Finishing	Polyester powder paint

ORDER CODE

WALL LAMP | BOLLARD

400 ---

<i>Finishing</i>	G	Black	
	H	Grey	
	L	Graphite	
	U	White	
	V	Oxide	
<i>Installation</i>	00	Upwards wall lamp	
	03	Bollard h. 30 cm	
	045	Bollard h. 45 cm	
	075	Bollard h. 75 cm	
	100	Bollard h. 100 cm	
	125	Bollard h. 125 cm	
<i>Diffuser</i>	.	Opal	

Example 400 . 045 G

ELECTRIFICATION

Bulb	Base type	Max wattage	Bulb dimension
	E27	25 W	Ø 6 x 15cm

AVAILABLE ACCESSORIES

Code	Description	Page
00A400	Root Mounting Kit h. 47 cm accessories not available for: 03	177
00A400.01P	Anchor bolt accessories not available for: 03	177
0404M003	Loop in loop out IP68 accessories not available for: 03	176
0404M004	Single connection IP68 accessories not available for: 03	176



Orion_2

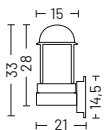

upwards wall lamp
cod. 00

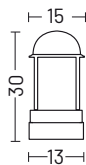

bollard
cod. 03

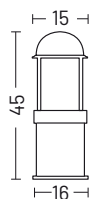

bollard
cod. 045

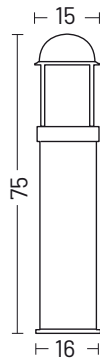

bollard
cod. 075

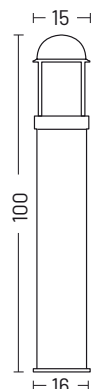

bollard
cod. 100



bollard
cod. 125

MATERIALS





Body	Die-cast aluminium EN47100 and extruded aluminium AW6060
Diffuser	Polycarbonate opal
Finishing	Polyester powder paint

ELECTRIFICATION

Bulb	Base type	Max wattage	Bulb dimension
	E27	25 W	Ø 6 x 15cm

ORDER CODE

WALL LAMP | BOLLARD

401	<i>Finishing</i>	G	Black	
		H	Grey	
		L	Graphite	
		U	White	
		V	Oxide	
		<i>Installation</i>	00	Upwards wall lamp
	03		Bollard h. 30 cm	
	045		Bollard h. 45 cm	
	075		Bollard h. 75 cm	
	100		Bollard h. 100 cm	
	125		Bollard h. 125 cm	
	<i>Diffuser</i>	.	Opal	
	<i>Example</i>	401 . 045 G		

AVAILABLE ACCESSORIES

Code	Description	Page
00A400	Root Mounting Kit h. 47 cm accessories not available for: 03	177
00A400.01P	Anchor bolt accessories not available for: 03	177
0404M003	Loop in loop out IP68 accessories not available for: 03	176
0404M004	Single connection IP68 accessories not available for: 03	176



Orion Inox_1

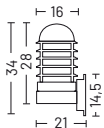

upwards wall lamp
cod. 00Z

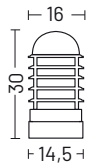

bollard
cod. 03Z

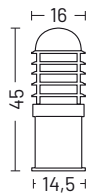

bollard
cod. 045Z

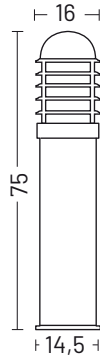

bollard
cod. 075Z

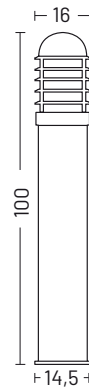

bollard
cod. 100Z



bollard
cod. 125Z

MATERIALS

Body	Stainless steel AISI 316L
Diffuser	Polycarbonate opal

ELECTRIFICATION

Bulb	Base type	Max wattage	Bulb dimension
	E27	25 W	Ø 6 x 15cm

ORDER CODE

WALL LAMP | BOLLARD

800	Installation	00Z	Upwards wall lamp
		03Z	Bollard h. 30 cm
		045Z	Bollard h. 45 cm
		075Z	Bollard h. 75 cm
		100Z	Bollard h. 100 cm
		125Z	Bollard h. 125 cm
	Diffuser	.	Opal
Example	800 . 045Z		

AVAILABLE ACCESSORIES

Code	Description	Page
00A400	Root Mounting Kit h. 47 cm accessories not available for: 03Z	177
00A400.01P	Anchor bolt accessories not available for: 03Z	177
0404M003	Loop in loop out IP68 accessories not available for: 03Z	176
0404M004	Single connection IP68 accessories not available for: 03Z	176



Orion Inox_2

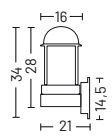

upwards wall lamp
cod. 00Z

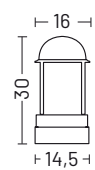

bollard
cod. 03Z

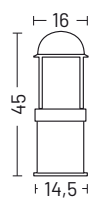

bollard
cod. 045Z

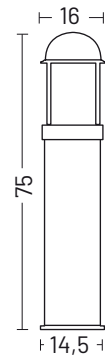

bollard
cod. 075Z

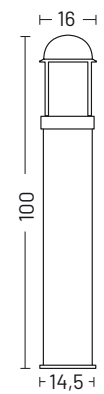

bollard
cod. 100Z



bollard
cod. 125Z

MATERIALS

Body	Stainless steel AISI 316L
Diffuser	Polycarbonate opal

ELECTRIFICATION

Bulb	Base type	Max wattage	Bulb dimension
	E27	25 W	Ø 6 x 15cm

ORDER CODE

WALL LAMP | BOLLARD

801			
	Installation	00Z	Upwards wall lamp
		03Z	Bollard h. 30 cm
		045Z	Bollard h. 45 cm
		075Z	Bollard h. 75 cm
		100Z	Bollard h. 100 cm
		125Z	Bollard h. 125 cm
	Diffuser	.	Opal
	Example	801 . 045Z	

AVAILABLE ACCESSORIES

Code	Description	Page
00A400	Root Mounting Kit h. 47 cm accessories not available for: 03Z	177
00A400.01P	Anchor bolt accessories not available for: 03Z	177
0404M003	Loop in loop out IP68 accessories not available for: 03Z	176
0404M004	Single connection IP68 accessories not available for: 03Z	176



Oslo

design by Landa R&D

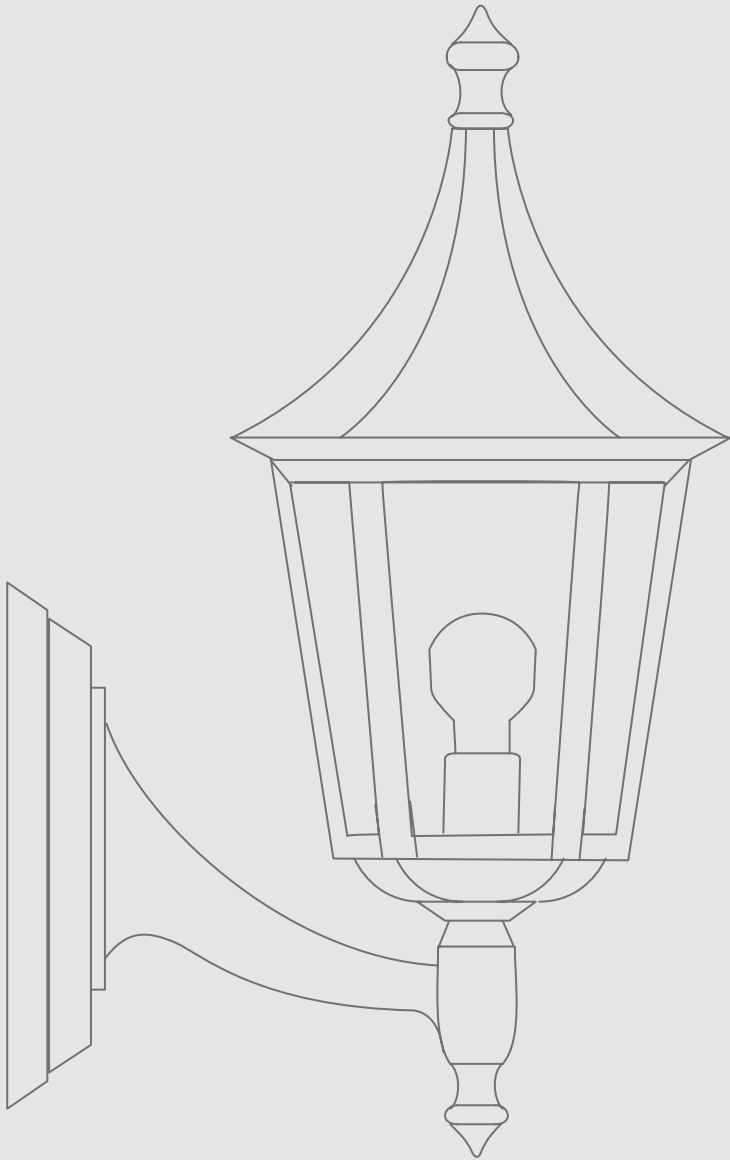

WALL LAMP

PENDANT

BOLLARD

POLE

EN Oslo is inspired by the majestic forms of Norwegian 'stavkirke' (stave churches) and Scandinavian architecture. The notoriously elaborate and imposing Gothic structures are reflected in the tapered lines and ornate details of Oslo, made of EN47100 die-cast aluminium with a glass diffuser. With options ranging from wall sconces to suspensions and from bollards to poles, this range offers versatile lighting solutions for pathways, gardens, and façades, embellishing any environment with a touch of Nordic austerity.

IT Oslo è ispirata alle forme maestose delle stavkirke norvegesi e all'architettura scandinava. Le strutture gotiche, notoriamente elaborate e imponenti, si rispecchiano nelle linee affusolate e nei dettagli ornati di Oslo, realizzate in alluminio pressofuso EN47100 con diffusore in vetro. Con opzioni che vanno dalle applique murali alle sospensioni e dai bollard ai pali, questa gamma offre soluzioni di illuminazione versatile per vialetti, giardini e facciate, impreziosendo ogni ambiente con un tocco di austerità nordica.

Oslo

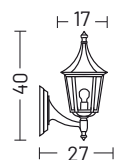

upwards wall lamp
cod. 00



downwards wall lamp
cod. 01



pendant
cod. 02



Bollard
cod. 33

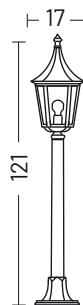

Bollard
cod. 44

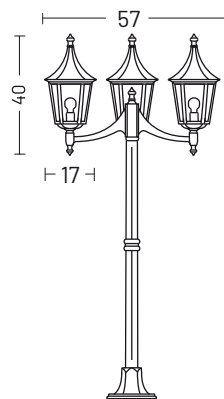





Pole cod.
PF5/PF6

MATERIALS





Body	Die-cast aluminium EN47100
Diffuser	Glass
Finishing	Polyester powder paint

ORDER CODE

WALL LAMP | PENDANT | BOLLARD

301 _ _ _	Finishing	G	Black	
		P	Black/Green	
		S	Black/Copper	
		U	White	
	Installation	00	Upwards wall lamp	
		01	Downwards wall lamp	
		02	Pendant	
		33	Bollard h. 49 cm	
		44	Bollard h. 121 cm	
	Diffuser	.	Transparent	
		Example	301 . 00 G	

POLE 3 LIGHTS

301 _ _ T3 _	Finishing	G	Black	
		P	Black/Green	
		S	Black/Copper	
		U	White	
	Pole style	PF5	pole h. 209 cm *	
		PF6	pole h. 247 cm *	
	Diffuser	.	Transparent	
		Example	301 . PF5 T3 G	

* post and head complete height

ELECTRIFICATION

Bulb	Base type	Max wattage	Bulb dimension
	E27	25 W	Ø 6 x 12cm

AVAILABLE ACCESSORIES

Code	Description	Page
00APF6	Anchor bolt for poles PF5/PF6	177
00108G	Corner bracket	176
0404M003	Loop in loop out IP68	176
0404M004	Single connection IP68	176



Parigi

design by Landa R&D

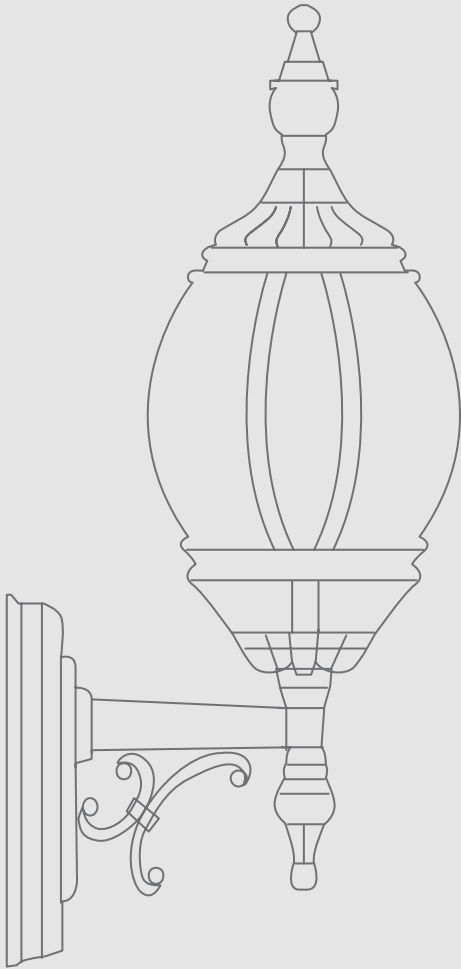

WALL LAMP

PENDANT

BOLLARD

POLE

EN The Parigi range captures the essence of the flair and elegance of the French capital. Each piece is meticulously designed to reflect the city's classic allure, characterised by its ornamental details and timeless aesthetics. The range includes several options, wall, suspension, bollard, and pole lamps, allowing for versatile application in both residential and commercial spaces. Perfect for adding a touch of romance to any outdoors, the Parigi series combines functionality with decorative grace, ensuring that each lighting element not only illuminates but also enhances its surroundings. Whether installed in a picturesque garden or along a busy street, these lights promise to bring a piece of Parisian flair to any setting.

IT La gamma Parigi cattura l'essenza del fascino e dell'eleganza della capitale francese. Ogni pezzo è progettato meticolosamente per riflettere l'allure classica della città, caratterizzata dai suoi dettagli ornamentali e dall'estetica senza tempo. La gamma include diverse opzioni, lampade da parete, sospensione, bollard e pali, consentendo un'applicazione versatile sia in spazi residenziali che commerciali. Perfette per aggiungere un tocco di atmosfera romantica a qualsiasi esterno, le serie Parigi combinano funzionalità con grazia decorativa, garantendo che ogni elemento illuminante non solo illumina ma anche valorizzi il suo ambiente. Che siano installate in un giardino pittoresco o lungo una strada affollata, questi apparecchi promettono di portare un pezzo di flair parigino in qualsiasi contesto.

Parigi Mini



half lantern

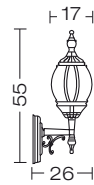

upwards wall lamp
cod. 00



downwards wall lamp
cod. 01

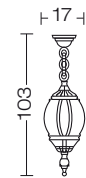

pendant
cod. 02



Bollard
cod. 33

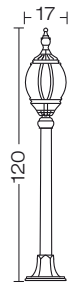

Bollard
cod. 44



1 light head

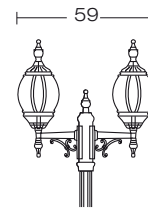

2 lights head
cod. T2

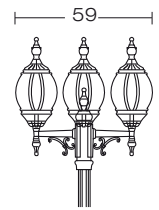

3 lights head
cod. T3



Pole
cod. PF4

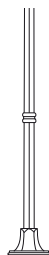

Pole
cod. PF5/PF6



Pole
cod. PR4

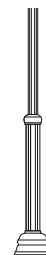

Pole
cod. PR5/PR6

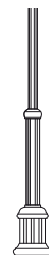





Pole
cod. PR7

MATERIALS





Body	Die-cast aluminium EN47100
Diffuser	Transparent polycarbonate
Finishing	Polyester powder paint

ORDER CODE





WALL LAMP | BOLLARD | PENDANT

370 ---	Finishing	G Black 
		P Black/Green 
		S Black/Copper 
		U White 
		Installation
		00 Upwards wall lamp
		01 Downwards wall lamp
		02 Pendant
		33 Bollard h. 55 cm
		44 Bollard h. 120 cm
	Diffuser	. Transparent
Example		370 . 00 G

POLE 1 LIGHT

370 ---	Finishing	G Black 
		P Black/Green 
		S Black/Copper 
		U White 
		Pole style
	PF5 pole 1L h. 216 cm *	
	PR4 pole 1L h. 138 cm *	
	PR5 adjustable h. 127-192 cm *	
	Diffuser	. Transparent
Example		370 . PF5 G

POLE 2 OR 3 LIGHTS

370 ---	Finishing	G Black 
		P Black/Green 
		S Black/Copper 
		U White 
		Lights
	T3 3 lights	
	Pole style	PF5 pole h. 227 cm *
		PF6 pole h. 265 cm *
		PR6 adjustable h. 160-243 cm *
		PR7 adjustable h. 165-230 cm *
	Diffuser	. Transparent
Example		370 . PR6 T2 G

ELECTRIFICATION

Bulb	Base type	Max wattage	Bulb dimension
	E27	LED 25 W	Ø 6 x 15cm

AVAILABLE ACCESSORIES

Code	Description	Page
00APF6	Anchor bolt for poles PF4/PF5/PF6	177
00APR6	Anchor bolt for poles PR5/PR6	177
00APR8	Anchor bolt for poles PR7	177
0404M003	Loop in loop out IP68	176
0404M004	Single connection IP68	176

* post and head complete height

Parigi_L1



upwards wall lamp
cod. 00

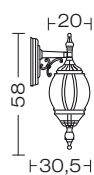

downwards wall lamp
cod. 01

MATERIALS





Body	Die-cast aluminium EN47100
Diffuser	Transparent polycarbonate
Finishing	Polyester powder paint

ELECTRIFICATION

Bulb	Base type	Max wattage	Bulb dimension
	E27	LED 25 W	Ø 6 x 15cm

ORDER CODE

WALL LAMP

371 _ _ _	<i>Finishing</i>	G	Black	
		P	Black/Green	
		S	Black/Copper	
		U	White	
	<i>Installation</i>	00	Upwards wall lamp	
		01	Downwards wall lamp	
	<i>Diffuser</i>	.	Transparent	

Example **371 . 01 G**



Parigi_2

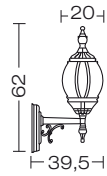

upwards wall lamp
cod. 00

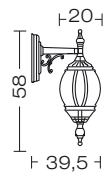

downwards wall lamp
cod. 01

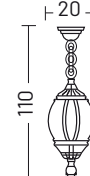

pendant
cod. 02



Bollard
cod. 33

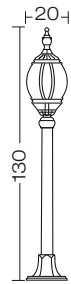

Bollard
cod. 44



1 light head

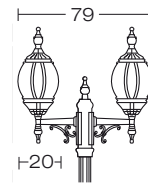

2 lights head
cod. T2

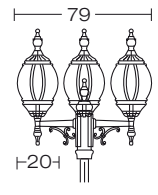

3 lights head
cod. T3

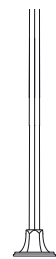

Pole
cod. PF4

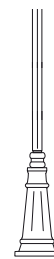

Pole
cod. PF7

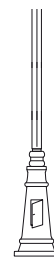

Pole
cod. PE7

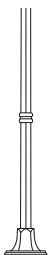

Pole
cod. PF5/PF6

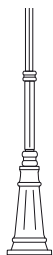

Pole
cod. PF8

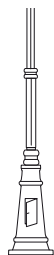

Pole
cod. PE8



Pole
cod. PR4

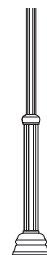

Pole
cod. PR5/PR6

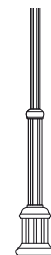

Pole
cod. PR7







Pole
cod. PR8

MATERIALS





Body	Die-cast aluminium EN47100
Diffuser	Transparent polycarbonate
Finishing	Polyester powder paint

ORDER CODE





WALL LAMP | BOLLARD | PENDANT

372	Finishing	G	Black	
		P	Black/Green	
		S	Black/Copper	
		U	White	
Installation	00	Upwards wall lamp		
	01	Downwards wall lamp		
	02	Pendant		
	33	Bollard h. 62 cm		
	44	Bollard h. 130 cm		
Diffuser	.	Transparent		
	Example	372.00G		

POLE 1 LIGHT

372	Finishing	G	Black	
		P	Black/Green	
		S	Black/Copper	
		U	White	
Pole style	PF4	pole 1L h. 167 cm*		
	PF5	pole 1L h. 223 cm*		
	PF6	pole 1L h. 261 cm*		
	PF7	pole 1L h. 203 cm*		
	PE7	pole 1L h. 203 cm*		
	PR4	pole 1L h. 145 cm*		
	PR5	adjustable h. 134-199 cm*		
	PR6	adjustable h. 153-237 cm*		
PR7	adjustable h. 160-224 cm*			
Diffuser	.	Transparent		
	Example	372 . PF5 G		

POLE 2 OR 3 LIGHTS

372	Finishing	G	Black	
		P	Black/Green	
		S	Black/Copper	
		U	White	
Lights	T2	2 lights		
	T3	3 lights		
Pole style	PF8	pole h. 272 cm*		
	PE8	pole h. 272 cm*		
	PR8	adjustable h. 202-267 cm*		
Diffuser	.	Transparent		
	Example	372 . PF8 T3 G		

ELECTRIFICATION

Bulb	Base type	Max wattage	Bulb dimension
	E27	LED 25 W	Ø 6 x 15cm

AVAILABLE ACCESSORIES

Code	Description	Page
00APF6	Anchor bolt for poles PF4/PF5/PF6	177
00APF8	Anchor bolt for poles PF7/PF8/PE7/PE8	177
00APR6	Anchor bolt for poles PR5/PR6	177
00APR8	Anchor bolt for poles PR7/PR8	177
0404M003	Loop in loop out IP68	176
0404M004	Single connection IP68	176

* post and head complete height

Parigi Maxi_1



upwards wall lamp
cod. 00



downwards wall lamp
cod. 01

Parigi Maxi_2

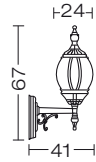

upwards wall lamp
cod. 00

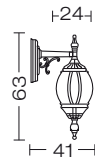

downwards wall lamp
cod. 01



pendant
cod. 02

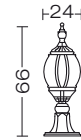

Bollard
cod. 33

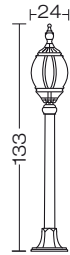

Bollard
cod. 44



1 light head



2 lights head
cod. T2



3 lights head
cod. T3

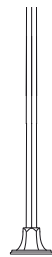

Pole
cod. PF4

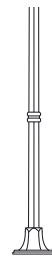

Pole
cod. PF5/PF6

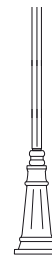

Pole
cod. PF7



Pole
cod. PF8/PF9



Pole
cod. PE7

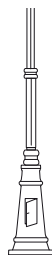

Pole
cod. PE8/PE9

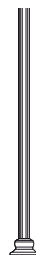

Pole
cod. PR4



Pole
cod. PR5/PR6

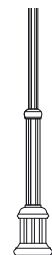

Pole
cod. PR7







Pole
cod. PR8

MATERIALS





Body	Die-cast aluminium EN47100
Diffuser	Transparent polycarbonate
Finishing	Polyester powder paint

ORDER CODE





WALL LAMP | BOLLARD | PENDANT

374	Finishing	G	Black		
		P	Black/Green		
		S	Black/Copper		
		U	White		
	Installation	00	Upwards wall lamp		
		01	Downwards wall lamp		
		02	Pendant		
		33	Bollard h. 66 cm		
		44	Bollard h. 133 cm		
	Diffuser	.	Transparent		
		Example	374 . 00 G		

POLE 1 LIGHT

374	Finishing	G	Black		
		P	Black/Green		
		S	Black/Copper		
		U	White		
	Pole style	PF4	pole 1L h. 168 cm *		
		PF5	pole 1L h. 224 cm *		
		PF6	pole 1L h. 262 cm *		
		PF7	pole 1L h. 204 cm *		
		PF8	pole 1L h. 262 cm *		
		PF9	pole 1L h. 300 cm *		
		PE7	pole 1L h. 204 cm *		
		PE8	pole 1L h. 262 cm *		
		PE9	pole 1L h. 300 cm *		
		PR4	pole 1L h. 148 cm *		
		PR5	adjustable h. 138-203 cm *		
		PR6	adjustable h. 157-241 cm *		
		PR7	adjustable h. 136-228 cm *		
		PR8	adjustable h. 193-258 cm *		
		Diffuser	.	Transparent	
	Example		374 . PF5 G		

POLE 2 OR 3 LIGHTS

374	Finishing	G	Black		
		P	Black/Green		
		S	Black/Copper		
		U	White		
	Lights	T2	2 lights		
		T3	3 lights		
	Pole style	PF8	pole h. 277 cm *		
		PF9	pole h. 315 cm *		
		PE8	pole h. 277 cm *		
		PE9	pole h. 315 cm *		
		PR8	adjustable h. 208-273 cm *		
	Diffuser	.	Transparent		
		Example	374 . PF8 T2 G		

ELECTRIFICATION

Bulb	Base type	Max wattage	Bulb dimension
	E27	LED 25 W	Ø 6 x 15cm

AVAILABLE ACCESSORIES

Code	Description	Page
00APF6	Anchor bolt for poles PF4/PF5/PF6	177
00APF8	Anchor bolt for poles PF7/PF8/PE7/PE8/PE9/PE9	177
00APR6	Anchor bolt for poles PR5/PR6	177
00APR8	Anchor bolt for poles PR7/PR8	177
0404M003	Loop in loop out IP68	176
0404M004	Single connection IP68	176

* post and head complete height

Pisa

design by Landa R&D

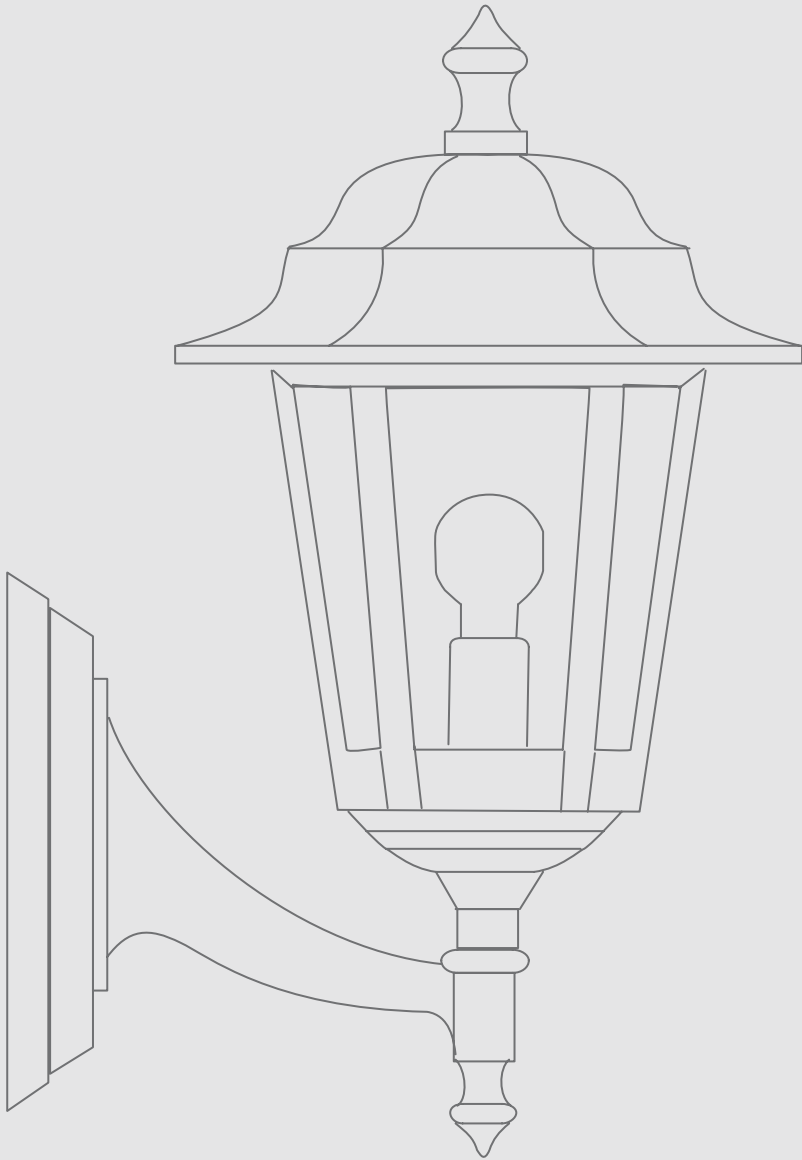

WALL LAMP

PENDANT

BOLLARD

POLE

EN Pisa combines robust materials and a classic design to offer an elegant and durable lighting solution. The lamp body is made of EN47100 die-cast aluminium, known for its corrosion resistance and durability. The glass diffuser not only protects the internal components, but also ensures optimal light fruition. Complemented by a polyester powder coating finish, this product is ideal for adding a touch of traditional style to outdoor spaces.

IT Pisa combina materiali robusti e un design classico per offrire una soluzione di illuminazione elegante e durevole. Il corpo della lampada è realizzato in alluminio pressofuso EN47100, noto per la sua resistenza alla corrosione e durata. Il diffusore in vetro non solo protegge i componenti interni, ma garantisce anche una fruizione ottimale della luce. Completata da una finitura in vernice a polvere di poliestere, questo prodotto è ideale per aggiungere un tocco di stile tradizionale agli spazi esterni.

Pisa

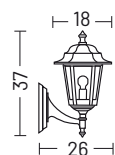

upwards wall lamp
cod. 00



downwards wall lamp
cod. 01

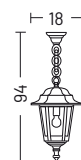

pendant
cod. 02



Bollard
cod. 33

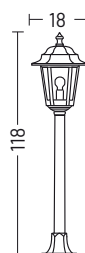

Bollard
cod. 44

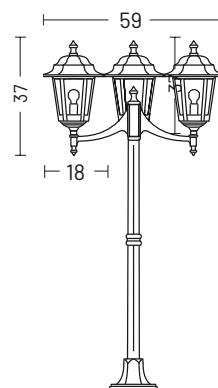

Pole cod.
PF5/PF6

MATERIALS

Body	Die-cast aluminium EN47100
Diffuser	Glass
Finishing	Polyester powder paint

ORDER CODE

WALL LAMP | PENDANT | BOLLARD

300 _ _ _	Finishing	G	Black	●	
		P	Black/Green	●	
		S	Black/Copper	●	
		U	White	●	
	Installation	00	Upwards wall lamp		
		01	Downwards wall lamp		
		02	Pendant		
		33	Bollard h. 46 cm		
		44	Bollard h. 118 cm		
	Diffuser	.	Transparent		
	Example	300 . 00 G			

POLE 3 LIGHTS

300 _ _ T3 _	Finishing	G	Black	●	
		P	Black/Green	●	
		S	Black/Copper	●	
		U	White	●	
	Pole style	PF5	pole h. 207 cm *		
		PF6	pole h. 245 cm *		
	Diffuser	.	Transparent		
	Example	300 . PF5 T3 G			

* post and head complete height

ELECTRIFICATION

Bulb	Base type	Max wattage	Bulb dimension
	E27	25 W	Ø 6 x 12cm

AVAILABLE ACCESSORIES

Code	Description	Page
00APF6	Anchor bolt for poles PF5/PF6	176
00108G	Corner bracket	177
0404M003	Loop in loop out IP68	176
0404M004	Single connection IP68	176



Polos

design by Landa R&D

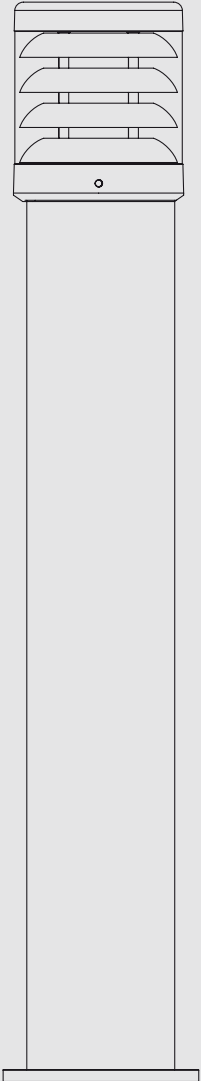

WALL LAMP



BOLLARD

EN Polos is the ideal product for lighting public and private outdoor spaces. A pole with a minimal and essential aesthetics, a synthesis of light and form. The body is made of EN47100 die-cast and AW6060 extruded aluminium, in the bollard version it reaches a height of 92 cm, available in Graphite, Grey and Oxide finishes. Functional, essential, Polos is excellent and resistant even in particularly extreme outdoor settings. Also available in a wall-mounted version.

IT Polos è il prodotto ideale per l'illuminazione di spazi esterni pubblici e privati. Un palo dall'estetica minimale ed essenziale, una sintesi di luce e forma. Il corpo è in alluminio pressofuso EN47100 ed estruso AW6060, nella versione bollard, raggiunge un'altezza di 92 cm, disponibile con finiture di color Grafite, Grigio e Ossido. Funzionale, essenziale, Polos è ottimo e resistente anche in ambientazioni outdoor particolarmente estreme. Disponibile anche la versione a parete.

Polos_1

IP64 IP65 EAC CE
wall bollard

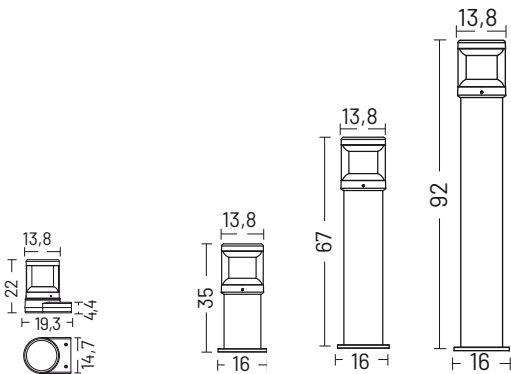

upwards wall lamp
cod. 10

bollard
cod. 035

bollard
cod. 070

bollard
cod. 090

MATERIALS

Body	Die-cast aluminium EN47100 and extruded aluminium AW6060
Diffuser	Transparent polycarbonate
Finishing	Polyester powder paint



ELECTRIFICATION

Bulb	Base type	Max wattage	Bulb dimension
	E27	LED 25 W	Ø 6 x 15cm

ORDER CODE

WALL LAMP | BOLLARD

4032

<i>Finishing</i>	H	Grey	
	L	Graphite	
	V	Oxide	
<i>Installation</i>	10	Upwards wall lamp	
	035	Bollard h. 35 cm	
	070	Bollard h. 67 cm	
	090	Bollard h. 92 cm	
<i>Diffuser</i>	.	Transparent	
<i>Example</i>	4032 . 070 V		

AVAILABLE ACCESSORIES

<i>Code</i>	<i>Description</i>	<i>Page</i>
00A405	Root Mounting Kit h. 47 cm	177
00A405.01P	Anchor bolt	177
0404M003	Loop in loop out IP68	176
0404M004	Single connection IP68	176



Polos_2

IP64 IP65 EAC CE
 wall bollard

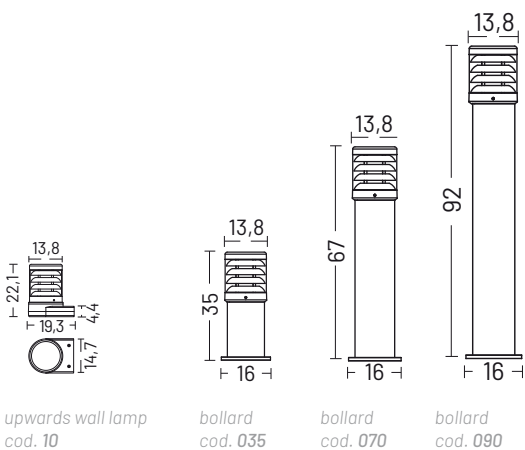



MATERIALS

Body	Die-cast aluminium EN47100 and extruded aluminium AW6060
Diffuser	Transparent polycarbonate
Finishing	Polyester powder paint

ORDER CODE

WALL LAMP | BOLLARD

4022	Finishing	H	Grey	
		L	Graphite	
		V	Oxide	
	Installation	10	Upwards wall lamp	
		035	Bollard h. 35 cm	
		070	Bollard h. 67 cm	
		090	Bollard h. 92 cm	
	Diffuser	.	Transparent	

Example 4022 . 035 V

ELECTRIFICATION

Bulb	Base type	Max wattage	Bulb dimension
	E27	LED 25 W	Ø 6 x 15cm

AVAILABLE ACCESSORIES

Code	Description	Page
00A405	Root Mounting Kit h. 47 cm	177
00A405.01P	Anchor bolt	177
0404M003	Loop in loop out IP68	176
0404M004	Single connection IP68	176



Rio

design by Landa R&D

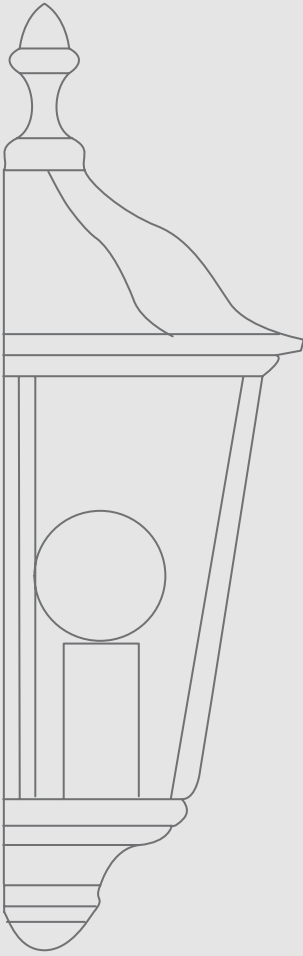

WALL LAMP

EN Combining functionality and aesthetics in a classically inspired design, Rio is perfect for adding a touch of elegance to any outdoor environment. This wall lamp is available with both transparent and opal diffusers, offering versatility in light distribution and created atmosphere. Made of EN 47100 die-cast aluminium, Rio is designed to last, and is treated with a polyester powder coating to withstand the outdoor elements. With its compact dimensions and different finish options, black, black/green, black/silver, black/copper or white, it fits easily into different residential contexts, bringing a touch of discreet elegance.

IT Combinando funzionalità e estetica in un design di ispirazione classica, Rio è perfetta per aggiungere un tocco di eleganza a qualsiasi ambiente esterno. Questa lampada da parete è disponibile con diffusori sia trasparenti che opalini, offrendo versatilità nella distribuzione della luce e nell'atmosfera creata. Realizzata in alluminio pressofuso EN 47100, Rio è progettata per durare, è trattata infatti con una vernice a polvere di poliestere per resistere agli agenti esterni. Con le sue dimensioni compatte e le diverse opzioni di finitura - nero, nero/verde, nero/argento, nero/rame o bianco, si adatta facilmente a diversi contesti residenziali, portando un tocco di raffinatezza discreta.

Rio



aluminium top



copper top



Opal



Transparent

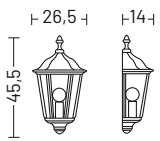

half wall lamp

MATERIALS







Body	Die-Cast aluminium EN47100
Diffuser	Polycarbonate
Finishing	Polyester powder paint

ELECTRIFICATION

Bulb	Base type	Max wattage	Bulb dimension
	E27	LED 25 W	Ø 6 x 15cm

ORDER CODE

WALL LAMP

425	<i>Finishing</i>	G	Black	
		P	Black/Green	
		R	Black/Silver	
		S	Black/Copper	
		U	White	
	<i>Diffuser</i>		transparent	
		B	Opal	
		SEN	Opal with Sensor	
	<i>Variant</i>		Aluminium top	
		A	Copper top	

Example 425 A G

Example 425 A SEN P (Optional Sensor)



Romantica

design by Landa R&D

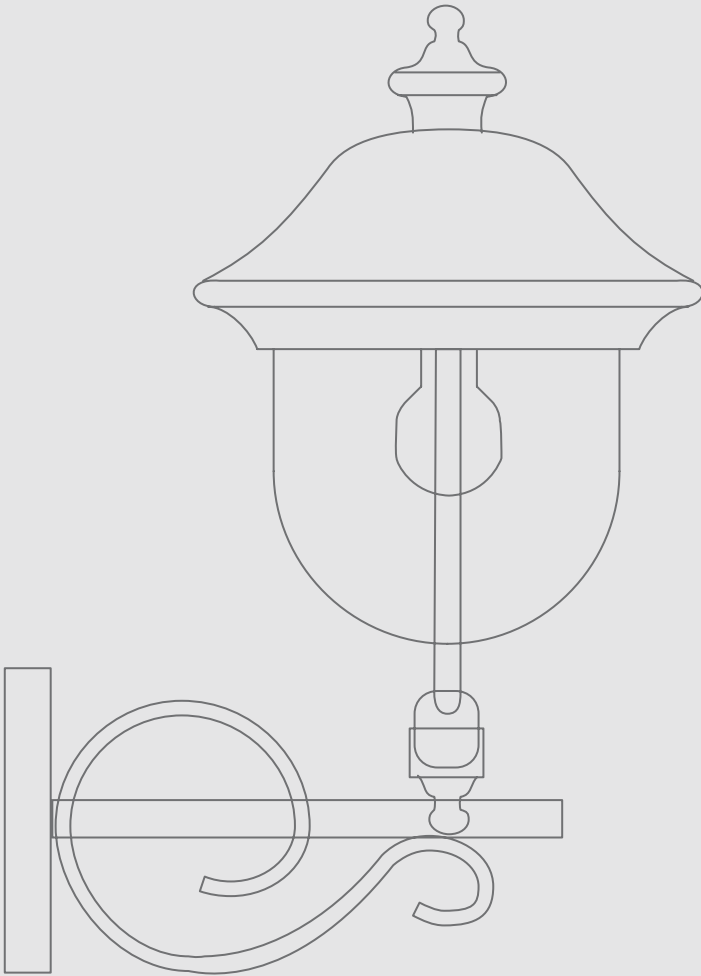

WALL LAMP

PENDANT

BOLLARD

POLE

EN The Romantica collection represents a refined fusion of classic elegance and modern details, designed to enrich outdoor environments with a touch of nostalgia. This series stands out for its versatility in design and functionality.

The lamps are made of EN47100 die-cast aluminium, known for its strength and durability, ideal for withstanding the outdoor elements for a long time. The polyester powder coating further protects each product, ensuring that the colour remains vivid and durable. You can choose between transparent diffusers, which project a bright, clear light, or opal diffusers, for a more diffuse and subtle lighting, allowing you to create the desired atmosphere in gardens, patios or along pathways.

Romantica comes not only in different forms - from elegant wall lamps that can be mounted to direct light upwards or downwards, to suspensions like jewels in the open air - but also offers bollards and poles in a range of styles and heights. This modularity allows the lighting to be customised to the specific needs of the landscape. Variants with aluminium or copper caps add a further degree of customisation, making each configuration unique.

IT La collezione Romantica rappresenta una fusione raffinata tra eleganza classica e dettagli moderni, pensata per arricchire ambienti esterni con un tocco di nostalgia. Questa serie si distingue per la sua versatilità nel design e nella funzionalità.

Le lampade sono costruite in alluminio pressofuso EN47100, noto per la sua resistenza e durata, ideali per resistere a lungo agli elementi esterni. La finitura in polvere poliestere protegge ulteriormente ogni prodotto, assicurando che il colore rimanga vivido e resistente nel tempo. È possibile scegliere tra diffusori trasparenti, che proiettano una luce chiara e brillante, o opalini, per un'illuminazione più diffusa e delicata, permettendo così di creare l'atmosfera desiderata in giardini, patio o lungo i sentieri.

Romantica si presenta non solo in forme diverse - dalle eleganti lampade da parete che possono essere montate per dirigere la luce verso l'alto o il basso, a sospensioni come gioielli all'aria aperta - ma offre anche bollard e pali in vari stili e altezze. Questa modularità permette di personalizzare l'illuminazione in base alle specifiche esigenze del paesaggio. Le varianti con cappelli in alluminio o rame aggiungono un ulteriore grado di personalizzazione, rendendo ogni configurazione unica.

Romantica

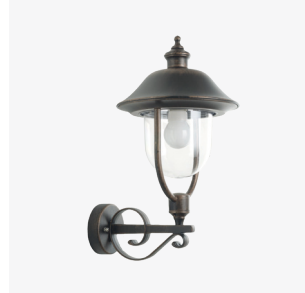

aluminium top



copper top

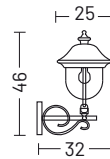

upwards wall lamp
cod. 00

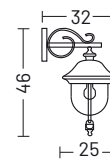

downwards wall lamp
cod. 01

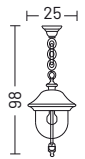

pendant
cod. 02

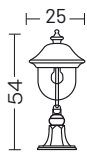

Bollard
cod. 33

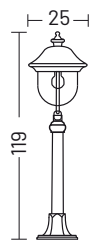

Bollard
cod. 44



1 light head

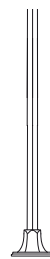

Pole
cod. PF4

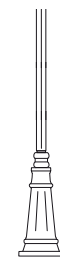

Pole
cod. PF7

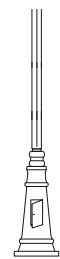

Pole
cod. PE7

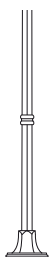

Pole cod.
PF5/PF6

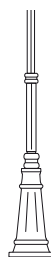

Pole cod.
PF8



Pole cod.
PE8

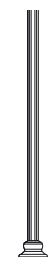

Pole cod.
PR4

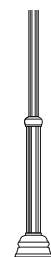

Pole cod.
PR5/PR6

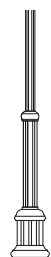





Pole cod.
PR7

MATERIALS





Body	Die-cast aluminium EN47100
Diffuser	Transparent polycarbonate
Finishing	Polyester powder paint

ORDER CODE

WALL LAMP | PENDANT | BOLLARD

350	Finishing	G	Black	
		P	Black/Green	
		R	Black/Silver	
		S	Black/Copper	
		U	White	
	Installation	00	Upwards wall lamp	
		01	Downwards wall lamp	
		02	Pendant	
		33	Bollard h. 54 cm	
		44	Bollard h. 119 cm	
	Variant	.	Aluminium top	
		A	Copper top	
	Example	350 A 00 G		

POLE 1 LIGHT

350	Finishing	G	Black	
		P	Black/Green	
		R	Black/Silver	
		S	Black/Copper	
		U	White	
	Pole style	PF4	pole 1L h. 156 cm *	
		PF5	pole 1L h. 212 cm *	
		PF6	pole 1L h. 250 cm *	
		PF7	pole 1L h. 192 cm *	
		PF8	pole 1L h. 250 cm *	
		PE7	pole 1L h. 192 cm *	
		PE8	pole 1L h. 250 cm *	
	Variant	PR4	pole 1L h. 136 cm *	
		PR5	adjustable h. 126-191 cm *	
		PR6	adjustable h. 145-229 cm *	
Variant	.	Aluminium top		
	A	Copper top		
Example	350 A PF5 G			

ELECTRIFICATION

Bulb	Base type	Max wattage	Bulb dimension
	E27	25 W	Ø 6 x 15cm

AVAILABLE ACCESSORIES

Code	Description	Page
00APF6	Anchor bolt for poles PF4/PF5/PF6	177
00APF8	Anchor bolt for poles PF7/PF8/PE7/PE8	177
00APR6	Anchor bolt for poles PR5/PR6	177
00APR8	Anchor bolt for poles PR7/PR8	177
00108G	Corner bracket	176
0404M004	Single connection IP68	176
0404M003	Loop in loop out IP68	176

* post and head complete height

Romantica

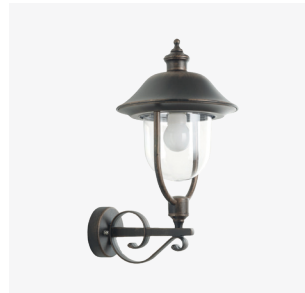

aluminium top



copper top

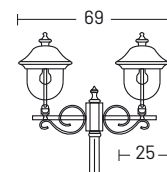

2 lights head
cod. T2

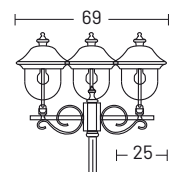

3 lights head
cod. T3

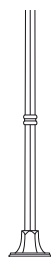

Pole cod.
PF6

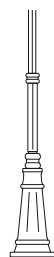

Pole cod.
PF8

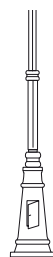

Pole cod.
PE8

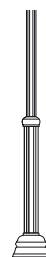

Pole cod.
PR6

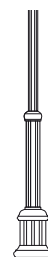

Pole cod.
PR7

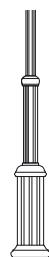





Pole cod.
PR8

MATERIALS

Body	Die-cast aluminium EN47100
Diffuser	Transparent polycarbonate
Finishing	Polyester powder paint

ORDER CODE

POLE 2 OR 3 LIGHTS

350	Finishing	G	Black			
		P	Black/Green			
		R	Black/Silver			
		S	Black/Copper			
		U	White			
	Lights	T2	2 lights			
		T3	3 lights			
		Pole style	PF6	pole h. 256 cm *		
			PF8	pole h. 256 cm *		
			PE8	pole h. 256 cm *		
	PR6		pole h. 151/235 cm *			
	PR7		pole h. 157/222 cm *			
	Variant	.	Aluminium top			
		A	Copper top			
	Example	350 A PF6 T3 G				

ELECTRIFICATION

Bulb	Base type	Max wattage	Bulb dimension
	E27	LED 15 W	Ø 6 x 15cm

AVAILABLE ACCESSORIES

Code	Description	Page
00APF6	Anchor bolt for poles PF6	177
00APF8	Anchor bolt for poles PF8/PE8	177
00APR6	Anchor bolt for poles PR6	177
00APR8	Anchor bolt for poles PR7/PR8	177
0404M004	Single connection IP68	176
0404M003	Loop in loop out IP68	176

* post and head complete height

Romantica_1

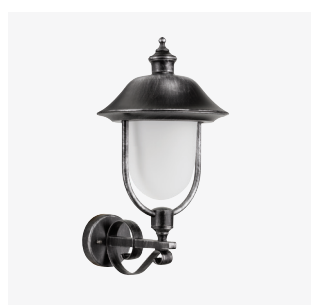

aluminium top

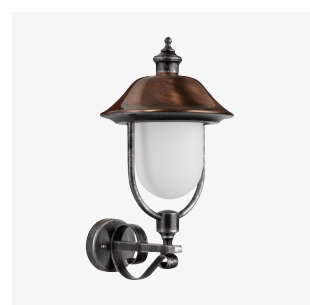

copper top

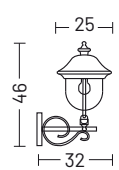

upwards wall lamp
cod. 00

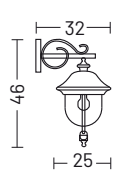

downwards wall lamp
cod. 01

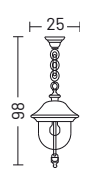

pendant
cod. 02

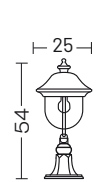

Bollard
cod. 33

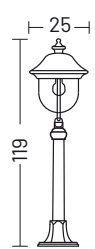

Bollard
cod. 44



1 light head



Pole
cod. PF7

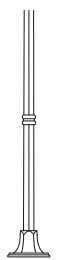

Pole
cod. PF4

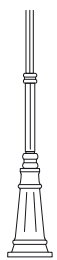

Pole
cod. PF8

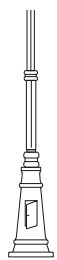





Pole
cod. PE8

MATERIALS





Body	Die-cast aluminium EN47100
Diffuser	Opal polycarbonate
Finishing	Polyester powder paint

ORDER CODE



WALL LAMP | PENDANT | BOLLARD

350 _ _ _ B _	Finishing	G Black	
		P Black/Green	
		R Black/Silver	
		S Black/Copper	
		U White	
	Source lamp	E27	
		LH LED	
	Installation	00 Upwards wall lamp	
		01 Downwards wall lamp	
		02 Pendant	
33 Bollard h. 54 cm			
44 Bollard h. 119 cm			
Variant	. Aluminium top		
	A Copper top		
Example	350 A 00 LH G		

POLE 1 LIGHT

350 _ _ _ B _	Finishing	G Black	
		P Black/Green	
		R Black/Silver	
		S Black/Copper	
		U White	
	Source lamp	E27	
		LH LED	
	Pole style	PF4 pole 1L h. 156 cm *	
		PF7 pole 1L h. 192 cm *	
		PF8 pole 1L h. 250 cm *	
PE8 pole 1L h. 250 cm *			
. Single colour			
Variant	A Copper top		
	Example	350 A PF8 LH G	

ELECTRIFICATION

Bulb	Base type	Max wattage	Bulb dimension
	E27	LED 15 W	Ø 6 x 15cm
	LH	LED 12 W	3000 K 1100 lm Ra80

AVAILABLE ACCESSORIES

Code	Description	Page
00APF6	Anchor bolt for poles PF4	177
00APF8	Anchor bolt for poles PF7/PF8/PE8	177
00APR8	Anchor bolt for poles PR8	177
00108G	Corner bracket	176
0404M004	Single connection IP68	176
0404M003	Loop in loop out IP68	176

* post and head complete height

Romantica_1

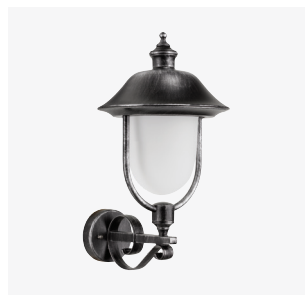

aluminium top

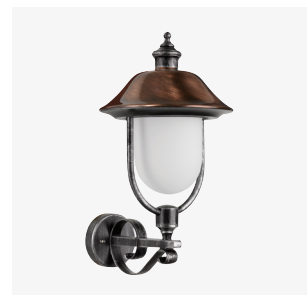

copper top

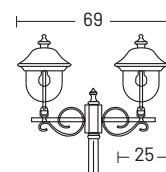

2 lights head
cod. T2

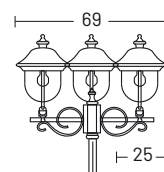

3 lights head
cod. T3

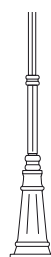

Pole cod.
PF8



Pole cod.
PE8







Pole cod.
PR8

MATERIALS



Body	Die-cast aluminium EN47100
Diffuser	Opal polycarbonate
Finishing	Polyester powder paint

ORDER CODE

POLE 2 OR 3 LIGHTS

350 - - - B -	Finishing	G	Black	
		P	Black/Green	
		R	Black/Silver	
		S	Black/Copper	
		U	White	
	Source lamp	E27		
		LH	LED	
	Lights	T2	2 lights	
		T3	3 lights	
	Pole style	PF8	pole h. 256 cm *	
		PE8	pole h. 256 cm *	
		PR8	pole h. 187/252 cm *	
	Variant	.	Aluminium top	
		A	Copper top	
	Example	350 A PF8 T3 LH G		

ELECTRIFICATION

Bulb	Base type	Max wattage	Bulb dimension
	E27	LED 15 W	Ø 6 x 15cm
	LH	LED 12 W	3000 K 1100 lm Ra80

AVAILABLE ACCESSORIES

Code	Description	Page
00APF8	Anchor bolt for poles PF8/PE8	177
00APR8	Anchor bolt for poles PR8	177
0404M004	Single connection IP68	176
0404M003	Loop in loop out IP68	176

* post and head complete height

Sirio

design by Landa R&D

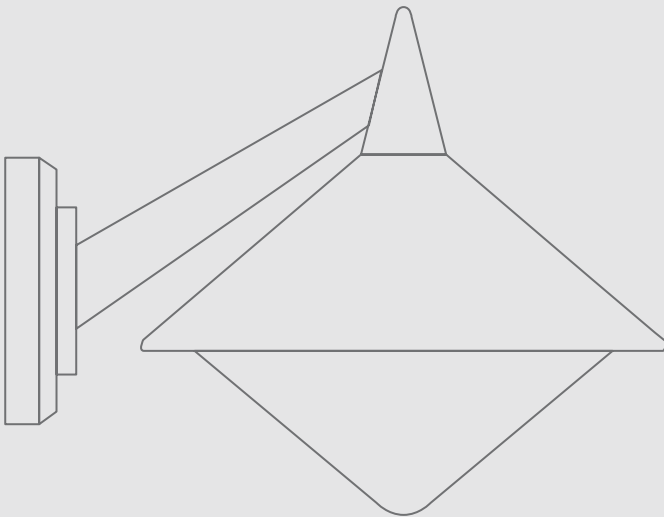

WALL LAMP

PENDANT

BOLLARD

POLE

EN The design of the Sirio range evokes the clean, futuristic lines of a spaceship, with its tapered, conical shape seeming to project upwards, almost ready for take-off. This modern, futuristic appearance makes Sirio an ideal choice for those who wish to add a distinctive, contemporary touch to their outdoor space. This series features mounting options ranging from simple downward-facing wall sconces, suspensions, and bollards to lighting poles that can support up to three lights, offering a scalable solution for different urban or garden scenarios. The EN 47100 die-cast aluminium structure guarantees durability and resistance to the outdoor elements, while the opal polycarbonate diffuser optimises light distribution, creating a welcoming and well-lit environment.

IT Il design della linea Sirio evoca le linee pulite e futuristiche di una navicella spaziale, con la sua forma conica e affusolata che sembra proiettarsi verso l'alto, quasi pronta per il decollo. Questo aspetto moderno e avveniristico fa di Sirio una scelta ideale per chi desidera aggiungere un tocco distintivo e contemporaneo al proprio outdoor. Questa serie è caratterizzata da opzioni di montaggio che vanno dalle semplici applique da parete verso il basso, sospensione, bollard fino ai pali di illuminazione che possono supportare fino a tre luci, offrendo una soluzione scalabile per diversi scenari urbani o giardini. La struttura in alluminio pressofuso EN 47100 garantisce durata e resistenza agli elementi, mentre il diffusore in policarbonato opale ottimizza la distribuzione della luce, creando un ambiente accogliente e ben illuminato.

Sirio

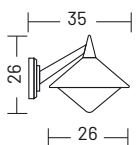

downwards wall lamp
cod. 01

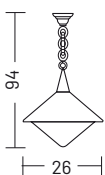

pendant
cod. 02

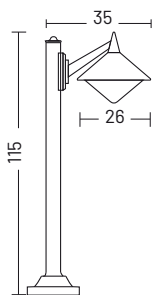

bollard
cod. P1.12

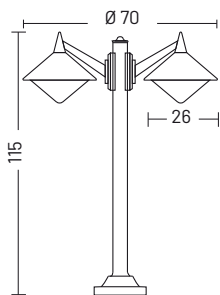

bollard
cod. P2.12

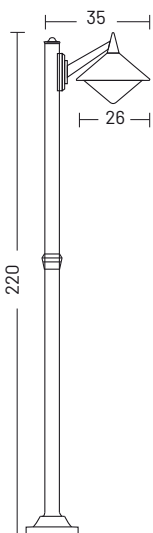

Pole | 1 light
cod. P1

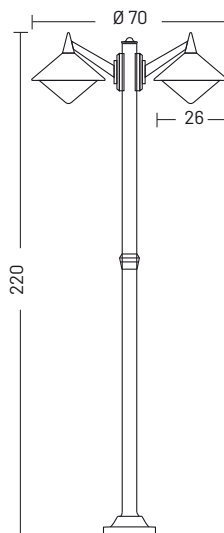

Pole | 2 lights
cod. P2

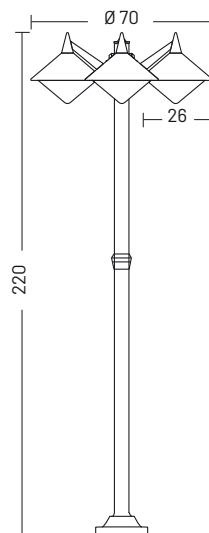

Pole | 3 lights
cod. P3

MATERIALS



Body	Die-cast aluminium EN47100
Diffuser	Opal polycarbonate
Finishing	Polyester powder paint

ELECTRIFICATION

Bulb	Base type	Max wattage	Bulb dimension
	E27	LED 25 W	Ø 6 x 12cm

ORDER CODE

WALL LAMP | PENDANT | BOLLARD

150	<i>Finishing</i>	G	Black	
		L	Graphite	
		U	White	
	<i>Installation</i>	01	Downwards wall lamp	
		02	Pendant	
		P1.12	bollard 1L	
		P1.12	bollard 2L	
		P1	pole 1L	
		P2	pole 2L	
		P3	pole 3L	
<i>Diffuser</i>	.	Opal		
<i>Example</i>	150 . 01 G			

AVAILABLE ACCESSORIES

Code	Description	Page
00108G	Corner bracket	176

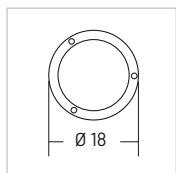

base dimensions



Titano

design by Landa R&D

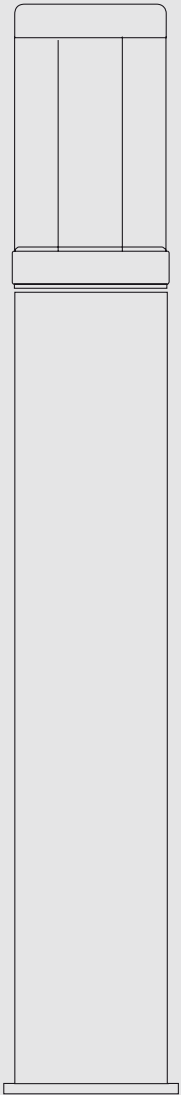

BOLLARD

EN Titano is a floor luminaire available in 4 different heights (45-75-100-125 cm), which can be easily integrated and installed in any type of outdoor environment. A simple shape for a practical and formal pole, robust and weatherproof. The optical emission is diffuse, precise, and uniform, also thanks to the transparent polycarbonate diffuser. Titano is available with an AISI 316L stainless steel body or in the EN AW6060 extruded aluminium version with the possibility of a Graphite and Oxide finish.

IT Titano è un apparecchio da terra disponibile in 4 differenti altezze (45-75-100-125 cm), facilmente integrabile e installabile in ogni tipologia di ambiente esterno. Una forma semplice per un paletto pratico e formale, robusto e inattaccabile dagli agenti atmosferici. L'emissione ottica è diffondente, precisa e uniforme, anche grazie al diffusore in polycarbonato trasparente. Titano è disponibile con corpo in acciaio inox AISI 316L o nella versione in alluminio estruso EN AW6060 e possibilità di finitura Grafite e Ossido.

Titano_1

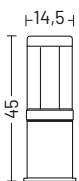

*bollard
cod. 045*

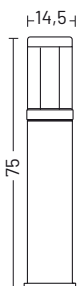

*bollard
cod. 075*



*bollard
cod. 100*





*bollard
cod. 125*

MATERIALS

Body	Stainless steel aisi316L and extruded aluminium AW6060
Diffuser	Transparent polycarbonate
Finishing	Polyester powder paint

ORDER CODE

BOLLARD				
824	Finishing	L	Graphite 	
		V	Oxide 	
	Installation	045	Bollard h. 45 cm	
		075	Bollard h. 75 cm	
		100	Bollard h. 100 cm	
		125	Bollard h. 125 cm	
	Diffuser	.	Transparent	
	Example	824 . 100 V		

ELECTRIFICATION

Bulb	Base type	Max wattage	Bulb dimension
	E27	LED 25 W	Ø 6 x 15cm

AVAILABLE ACCESSORIES

Code	Description	Page
00A400	Root Mounting Kit h .47 cm	177
00A400.01P	Anchor bolt	177
0404M003	Loop in loop out IP68	176
0404M004	Single connection IP68	176



Titano_2

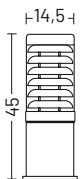

*bollard
cod. 045*

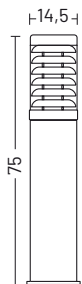

*bollard
cod. 075*



*bollard
cod. 100*





*bollard
cod. 125*

MATERIALS

Body	Stainless steel aisi316L and extruded aluminium AW6060
Diffuser	Transparent polycarbonate
Finishing	Polyester powder paint

ORDER CODE

BOLLARD

825	Finishing	L	Graphite		
		V	Oxide		
	Installation	045	Bollard h. 45 cm		
		075	Bollard h. 75 cm		
		100	Bollard h. 100 cm		
		125	Bollard h. 125 cm		
	Diffuser	.	Transparent		
	Example	825 . 100 L			

ELECTRIFICATION

Bulb	Base type	Max wattage	Bulb dimension
	E27	LED 25 W	Ø 6 x 15cm

AVAILABLE ACCESSORIES

Code	Description	Page
00A400	Root Mounting Kit h. 47 cm	177
00A400.01P	Anchor bolt	177
0404M003	Loop in loop out IP68	176
0404M004	Single connection IP68	176



Titano Inox

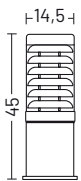

*bollard
cod. 045Z*

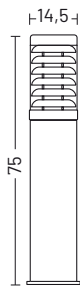

*bollard
cod. 075Z*

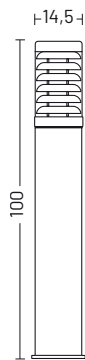

*bollard
cod. 100Z*



*bollard
cod. 125Z*

MATERIALS

Body	Stainless steel Aisi316L
Diffuser	Transparent polycarbonate

ELECTRIFICATION

Bulb	Base type	Max wattage	Bulb dimension
	E27	LED 25 W	Ø 6 x 15cm

ORDER CODE

BOLLARD	
822 _ _ Z	
Installation	045 Bollard h. 45 cm
	075 Bollard h. 75 cm
	100 Bollard h. 100 cm
	125 Bollard h. 125 cm
Diffuser	. Transparent
Example	822 . 100 Z

AVAILABLE ACCESSORIES

Code	Description	Page
00A400	Root Mounting Kit h. 47 cm	177
00A400.01P	Anchor bolt	177
0404M003	Loop in loop out IP68	176
0404M004	Single connection IP68	176



Pole

design by Landa R&D

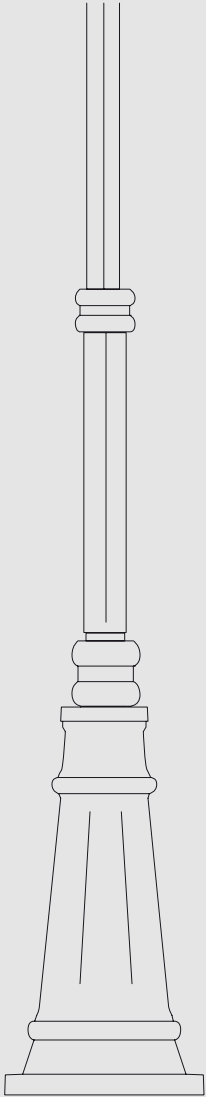

Pole

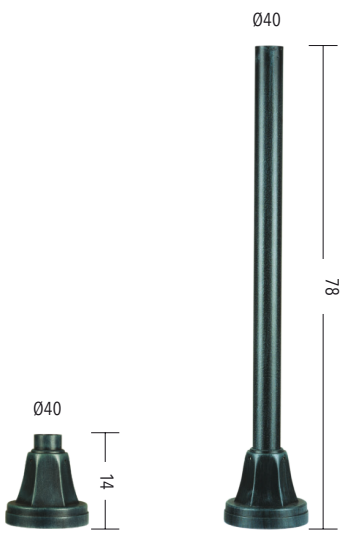

33

44

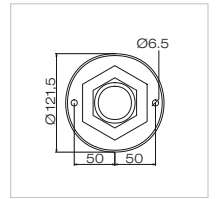

Pole_PF

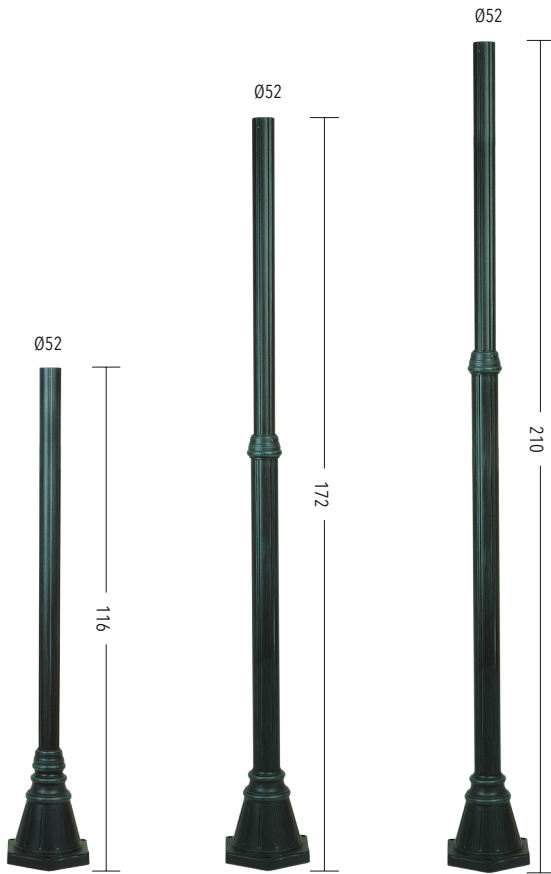

PF4 PF5 PF6



AVAILABLE ACCESSORIES

Code	Description
00APF6	Anchor bolt
00CRP_	Banner stand

Finishing	Color	Color swatch
G	Black	●
P	Black/Green	●
R	Black/Silver	●
S	Black/Copper	●
U	White	●

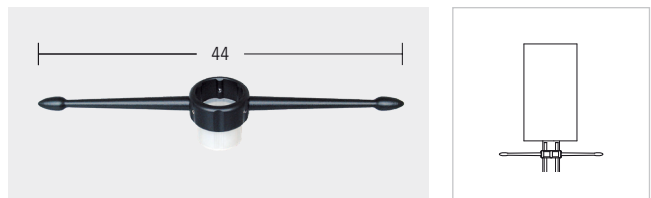

cod. 00CRP

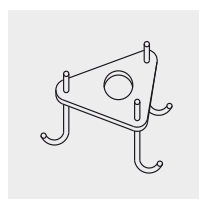

cod. 00APF6

Pole_PF









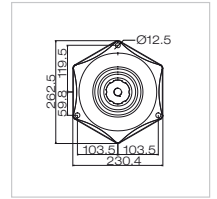
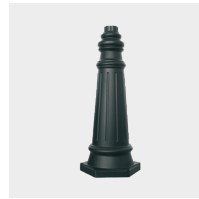







PF7

PF8

PF9



AVAILABLE ACCESSORIES

Code	Description																
00APF8	Anchor bolt																
00CRP_	Banner stand																
<table border="0"> <tr> <td rowspan="5">Finishing</td> <td>G</td> <td>Black</td> <td></td> </tr> <tr> <td>P</td> <td>Black/Green</td> <td></td> </tr> <tr> <td>R</td> <td>Black/Silver</td> <td></td> </tr> <tr> <td>S</td> <td>Black/Copper</td> <td></td> </tr> <tr> <td>U</td> <td>White</td> <td></td> </tr> </table>		Finishing	G	Black		P	Black/Green		R	Black/Silver		S	Black/Copper		U	White	
Finishing	G		Black														
	P		Black/Green														
	R		Black/Silver														
	S		Black/Copper														
	U	White															

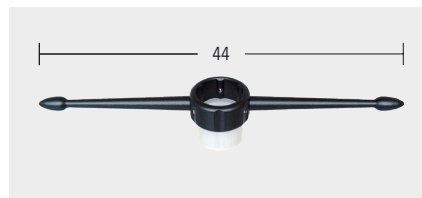

cod. 00CRP

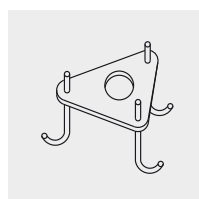
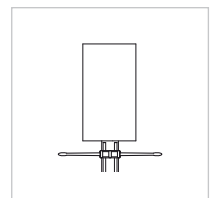

cod. 00APF8

Pole_PE



PE7 PE8 PE9

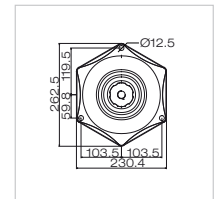

AVAILABLE ACCESSORIES

Code	Description
00PF8	Anchor bolt
00CRP_	Banner stand

Finishing	Color	Sample
G	Black	●
P	Black/Green	●
R	Black/Silver	●
S	Black/Copper	●
U	White	●

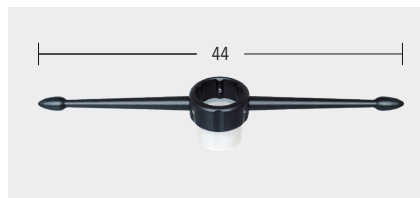

cod. 00CRP

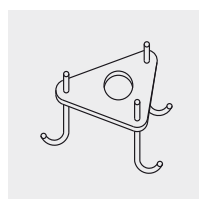
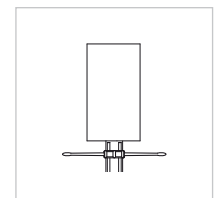

cod. 00APF8

Pole_PR

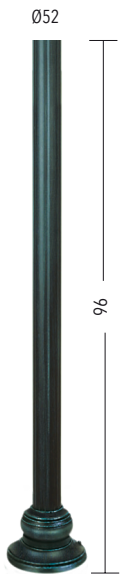

PR4

AVAILABLE ACCESSORIES

Code	Description
00CRP	Banner stand

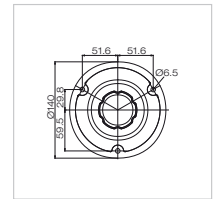

AVAILABLE ACCESSORIES

Code	Description
00CRP_	Banner stand
<i>Finishing</i>	
G	Black ●
P	Black/Green ●
R	Black/Silver ●
S	Black/Copper ●
U	White ●

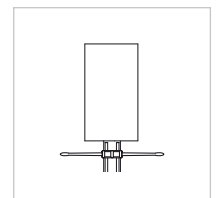
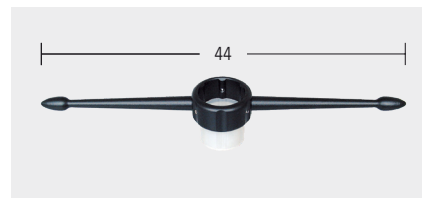



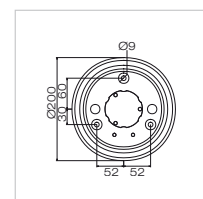
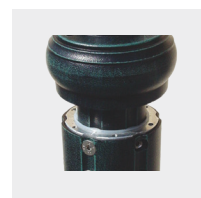
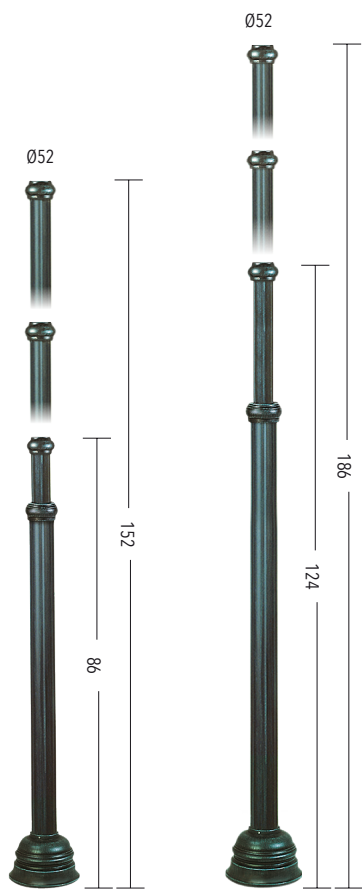











cod. 00CRP



PR5 PR6

AVAILABLE ACCESSORIES

Code	Description																
00APR6	Anchor bolt																
00CRP_	Banner stand																
<table border="0"> <tr> <td rowspan="5">Finishing</td> <td>G</td> <td>Black</td> <td></td> </tr> <tr> <td>P</td> <td>Black/Green</td> <td></td> </tr> <tr> <td>R</td> <td>Black/Silver</td> <td></td> </tr> <tr> <td>S</td> <td>Black/Copper</td> <td></td> </tr> <tr> <td>U</td> <td>White</td> <td></td> </tr> </table>		Finishing	G	Black		P	Black/Green		R	Black/Silver		S	Black/Copper		U	White	
Finishing	G		Black														
	P		Black/Green														
	R		Black/Silver														
	S		Black/Copper														
	U	White															

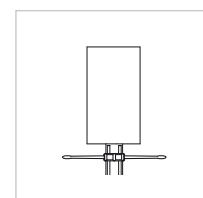

cod. 00CRP

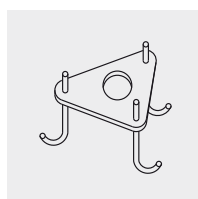

cod. 00APR6

Pole_PR



PR7

PR8

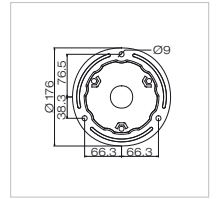

AVAILABLE ACCESSORIES

Code

Description





00APR8

Anchor bolt

00CRP_

Banner stand

Finishing

G	Black	
P	Black/Green	
R	Black/Silver	
S	Black/Copper	
U	White	

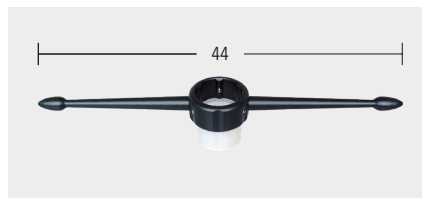



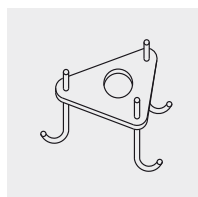
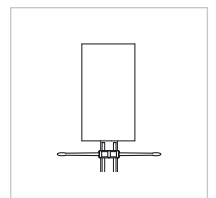























cod. 00CRP









cod. 00APR8

ACCESSORIES

Accessories

Code	Description																						
00108G	Corner bracket																						
00596_	Corner bracket																						
	<table border="1"> <thead> <tr> <th>Finishing</th> <th></th> <th></th> </tr> </thead> <tbody> <tr> <td>G</td> <td>Black</td> <td></td> </tr> <tr> <td>L</td> <td>Graphite</td> <td></td> </tr> <tr> <td>V</td> <td>Oxide</td> <td></td> </tr> <tr> <td>P</td> <td>Black/Green</td> <td></td> </tr> <tr> <td>R</td> <td>Black/Silver</td> <td></td> </tr> <tr> <td>S</td> <td>Black/Copper</td> <td></td> </tr> </tbody> </table>	Finishing			G	Black		L	Graphite		V	Oxide		P	Black/Green		R	Black/Silver		S	Black/Copper		
Finishing																							
G	Black																						
L	Graphite																						
V	Oxide																						
P	Black/Green																						
R	Black/Silver																						
S	Black/Copper																						
00KR175U	Reflector																						
00CRP	Banner stand																						
0404M003	Loop-in loop-out IP68																						
0404M004	Single connection IP68																						
0404M009	Single connection IP68																						
0404M010	Single connection IP68																						
0404M011	Single connection IP68																						

Code	Description	
00DEC	Degreasing liquid	
00A_	Anchor bolt	
<i>Finishing</i>	170.01P	
PF6	PF4/PF5/PF6	
PF8	PF7/PF8/PF9/PE7/ PE8/PE9	
PL6	P1/P2/P3	
PR6	PR5/PR6	
PR8	PR7/PR8	
00A400	Root mounting kit	
00A400.01P	Anchor bolt	
00A405	Root mounting kit	
00A405.01P	Anchor bolt	

INFORMATION

how to read the catalogue

product name
nome prodotto

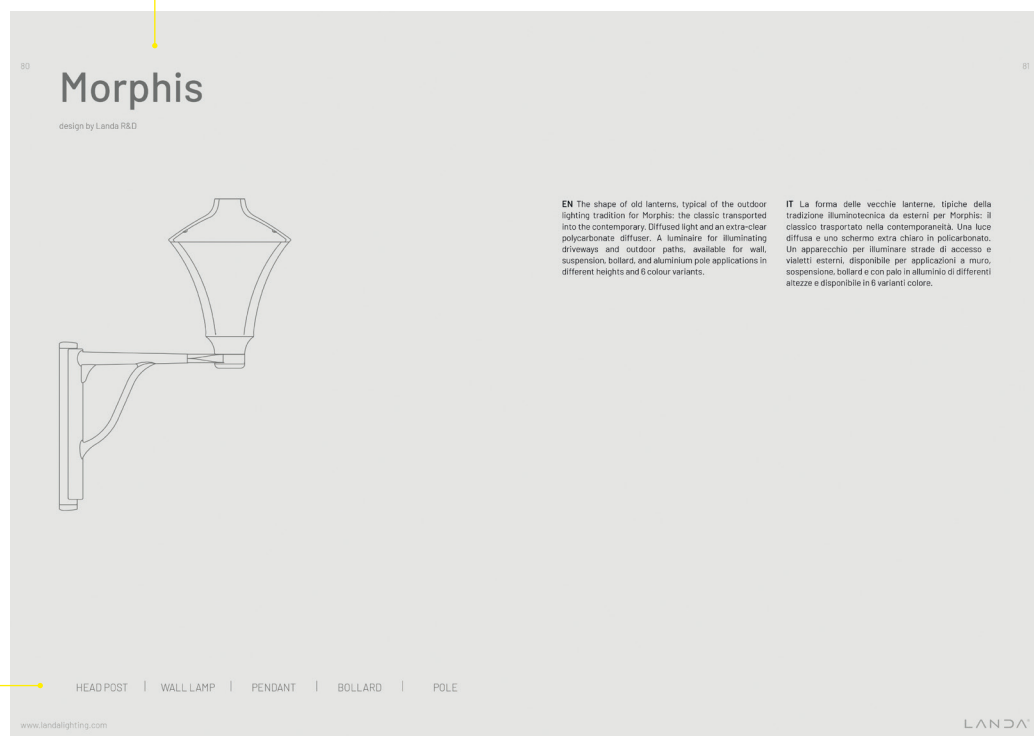

family abacus
abaco di famiglia

product name
nome prodotto

certifications
certificazioni

88
Morphis Wall_1



89





Transparent



Opal



not wall lamp

MATERIALS

Body: Die-cast aluminum EN61003

Diffuser: Polycarbonate

Finishing: Polyester powder paint

ELECTRIFICATION

Bulb	Bulb type	Max wattage	Bulb dimension
	E27	LED 25 W	Ø 6 x 115mm

ORDER CODE

WALL LAMP

FS ...

Finishing	D	Black	<input checked="" type="radio"/>
	L	Graphite	<input type="radio"/>
	P	Black/Green	<input type="radio"/>
	R	Black/Silver	<input type="radio"/>
	S	Black/Copper	<input type="radio"/>
	V	Opale	<input type="radio"/>

Diffuser

Transparent

B Opal

BSEN Opal with Sensor

Example: FS D

Example: FS SEN P (optional Sensor)



www.landaighting.com

LANDA®

drawing quoted in cm
disegno quotato in cm

technical information
informazioni tecniche

Installation

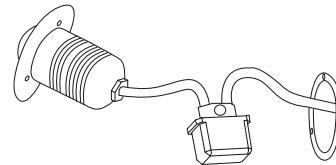

RECOMMENDED CONNECTION
CONNESSIONE CONSIGLIATA

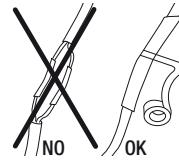

ALTERNATIVELY SELF-AMALGAMATING TAPE CONNECTION
CONNESSIONE ALTERNATIVA CON NASTRO AUTOAGGLOMERANTE

EN The LED lamps are electronic devices and hence sensitive to current surges. For this reason we recommend installing a suitable protective equipment (SPD) so as to protect the equipment from the potential damage.

Should the glass break, the product cannot be used and you should contact the manufacturer for its replacement.

If the external cable of this appliance is damaged, it must be replaced by the manufacturer in order to avoid dangers. For wiring the terminal you should use a suitable terminal approved to EN 60998-2-1 or EN 60998-2-2 installed in a wiring box with adequate degree of protection IP68.

The LED module contained in this luminaire it must be substituted exclusively of the manufactured, or personnel qualified equivalent.

IT Le lampade a LED sono apparecchiature elettroniche e quindi sensibili alle sovratensioni, per questo motivo si consiglia l'installazione nell'impianto di un dispositivo di protezione adeguato (SPD) così da proteggere gli apparecchi dal rischio di danneggiamento.

In caso di rottura del vetro il prodotto non può essere utilizzato, contattare il fornitore per la sua sostituzione. Se il cavo flessibile esterno di questo apparecchio viene danneggiato, deve essere sostituito dal costruttore al fine di evitare pericoli. Per il cablaggio dell'apparecchio si dovrà utilizzare un'adeguata morsettiere omologata EN60998-2-1 o EN60998-2-2 installata in una scatola di cablaggio adeguata con grado di protezione IP68.

Il modulo LED contenuto in questo apparecchio di illuminazione deve essere sostituito esclusivamente dal costruttore, o da personale qualificato equivalente.



SPECIFICATIONS

Detection range:	160°
Power supply:	230-240 V
Power frequency:	50/60Hz
Reach:	1-8 m (0), adjustable
Time setting:	10 sec to 12 min
Light control:	2-2000 LUX
Diffuser:	Opal polycarbonate



Morphis



Rio



Maiorca

index by code

62	100	lampara_1
64	100	lampara_2
154	150	sirio
84	175	morphis_2
88	175	morphis wall_1
86	176	morphis_3
82	177	morphis_1
130	300	pisa
114	301	oslo
30	320	amalfi_mini
34	321	amalfi_short
32	322	amalfi
36	323	amalfi_maxi
56-58	330	firenze
76-78	340	monaco
144-146	350	romantica
148-150	350	romantica_1
40-42	360	augusta
118	370	parigi_mini
120	371	parigi_1
122	372	parigi_2
124	373	parigi_maxi_1
126	374	parigi_maxi_2
100	390	nizza_2
98	391	nizza_1
104	400	orion_1
106	401	orion_2
92-94	405	neway
46	410-411	brick_light
48	412-413	brick_light_inox
52	420	cipro
72	421	maiorca
140	425	rio

index by code

108	800	orion inox_1
110	801	orion inox_2
162	822	titano inox
158	824	titano_1
160	825	titano_2
136	4022	polos_2
134	4032	polos_1
68	4652	lyras 80.1

Family abacus

	<i>wall lamps</i>	<i>wall recessed</i>	<i>pendants</i>	<i>bollards</i>	<i>poles</i>	<i>sensor</i>
amalfi	•			•	•	
augusta	•		•	•	•	
brick light		•				
cipro	•					
firenze	•		•	•	•	
lampara	•		•	•	•	
lyras	•					
maiorca	•					•
monaco	•		•	•	•	
morphis	•		•	•	•	•
neway	•			•		
nizza	•		•	•	•	
orion	•			•		
oslo	•		•	•	•	
parigi	•		•	•	•	
pisa	•		•	•	•	
polos	•			•		
rio	•					•
romantica	•		•	•	•	
sirio	•		•	•	•	
titano				•		

General information

PROTECTION GRADE GRADO DI PROTEZIONE

IP 43

*Protected against penetration of solid bodies $\varnothing > 1$ mm and protected against rain
Protetto contro la penetrazione dei colpi solidi $\varnothing > 1$ mm e contro la pioggia*

IP 44

*Protected against penetration of solid bodies $\varnothing > 1$ mm and protected against water sprays
Protetto contro la penetrazione dei colpi solidi $\varnothing > 1$ mm e contro gli spruzzi d'acqua*

IP 65

*Luminaire dust-tight and protected against water jets
Apparecchio stagno alla polvere e protetto da getti di acqua*

IP 66

*Luminaire dust-tight and protected against powerful water jets
Apparecchio stagno alla polvere e protetto dalle onde*

IP 67

*Luminaire dust-tight and sealed against temporary immersion
Apparecchio stagno alla polvere e all'immersione temporanea*

Quality certifications



CE

*Indicates that the product is certified according to European standards
Indica che il prodotto è certificato secondo le norme europee*



EAC

*Indicates that the product conforms to all technical regulations of the evaluation procedures of the Eurasian Customs Union
Indica che il prodotto si adegua a tutte le normative tecniche delle procedure di valutazione dell'Unione doganale eurasiatica*

Finishes

POLYESTER POWDER PAINT

VERNICIATURA CON POLVERI DI POLIESTERE

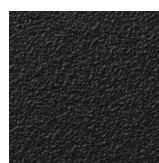

G Black
Nero



L Graphite
Grafite



S Black/copper
Nero/rame



H Grey
Grigio

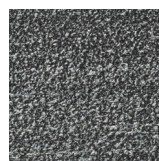

R Black/silver
Nero/argento

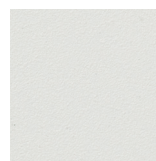

U White
Bianco

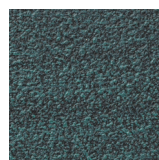

P Black/green
Nero/verde



V Oxide
Oxide



Z Stainless steel AISI316L
Inox AISI 316L

Terms & conditions

GENERAL

Buyer means the person, firm or company who purchases Goods from the company.
 Company means Landa Illuminotecnica S.p.A. via Rosmini 13/15, 25065 Lumezzane (BS), Italy.
 Contract means the Contract between the Buyer and the Company for the sale and purchase of Goods.
 Goods means the Goods which the Company is to supply in accordance with these conditions.

BASIC OF SALE

The Company shall sell and the Buyer shall purchase the Goods in accordance with these conditions, which shall govern the Contract to the exclusion of any other terms and conditions which the Buyer purports to apply under any purchase order, confirmation order, specification or other document.
 No variation to these conditions shall be binding unless agreed in writing by the Company.
 Any typographical, clerical or other error or omission in any sales literature, quotation, price list, acceptance of offer, invoice or other document or information issued by the Company shall be subject to correction without liability on the part of the Company.
 Goods supplied may vary in detail from illustrations, drawings, measurements and descriptions set out in the Company sales literature, which are approximate and for guidance only and will not form part of the Contract. Colour finishes will be maintained as accurately as possible but matching cannot be guaranteed. All terminology used in the Company's sales literature is subject to these conditions.

ORDERS

No order submitted by the Buyer shall be deemed to be accepted by the Company unless and until confirmed in writing by the Company.
 The Buyer shall be responsible to the Company for ensuring the accuracy of the terms of any order submitted by the Buyer, and for giving the Company any necessary information relating to the Goods within a sufficient time to enable the Company to perform the Contract in accordance with its terms.
 No Goods may be returned to the Company without the Company's prior written consent and must be returned in their original packaging to ensure no damage is sustained during transit. The Buyer shall be liable for the cost of returning the Goods and for any damage to the Goods prior to receipt by the Company of such returned Goods.

PRICE OF GOODS

The price of the Goods shall be the price listed in the Company's published price list in EURO currency.
 Unless otherwise agreed in writing between the Buyer and the Company, all prices are given by the Company on an ex-works basis, and where the Company agrees to deliver the Goods otherwise than at the Company's premises. The Buyer shall be liable to pay the Company's charges for transport.

WARRANTIES

Outdoor lighting fixtures are guaranteed against defects in material or workmanship for a period of two years following the date of delivery ex-works.
 No warranty is granted in connection with faults resulting from improper use, application, normal wear and tear, external influences or use of non-original replacement parts, damage resulting from transportation.
 The Company recommends that the installation of outdoor lighting fixtures is made by a skilful person and that the enclosed assembly instructions are followed and kept for further future maintenance.
 The Company will not assume responsibility for corrosion or other resulting damage to the Goods where they are installed in areas in which fertilizer or salt are present, either in the air or in the soil or where Goods are installed near to chemical plants etc with emissions of heavily polluted air.
 The Buyer undertakes to inform his customers about the regular maintenance of the products. In particular for the products in stainless steel AISI 316, by means of the technical sheets included in his catalogue, the distributor will inform his customer regarding the specific products (among which also those available from the Company aimed to remove possible colour spots) liable to keep the features of the products unaltered. Claims should be promptly submitted in a written form to the Company together with copy of the purchase invoice and stating the delivery date, description of the faults and quantity of faulty products. Products that are proved to be defective in material or workmanship will be repaired, replaced by the Company within a reasonable period after the claim. Returns of faulty Goods will be accepted by the Company only upon written authorization, adequately despatched and packed with transport prepaid. Extra costs borne by the Buyer in consequence of the faults of the products will not be carried by the Company, if not previously agreed in written form.
 The Company will not assume any responsibility in the following cases:
 improper assembly, use or maintenance of the products and their incorrect conservation.
 This guarantee shall not apply to products that have been altered, improperly used or installed or repaired without prior written authorization from the Company. If quality and performance have become less due to the application of accessories not approved by the Company. This guarantee deletes and replaces any other further responsibility arising from the products supplied; in particular the Buyer shall have no right to claim for damages reimbursement (indirect or consequent damages included or profit losses) reduction of prices or resolution of the Contract.

LANDA®

Technical: Landa S.p.A.
Concept & Graphic Design: ASB\COMUNICAZIONE
Print: ColorArt

Landa Illuminotecnica S.p.A. reserves itself the faculty to change or to modify, without advance notice, the dimensions and the technical characteristics of the products indicated in this catalogue, due to operative necessities to improve the functionality or updating with law regulation.

Landa Illuminotecnica S.p.A. si riserva la facoltà di variare o modificare, senza preavviso, le dimensioni e le caratteristiche tecniche dei prodotti indicati in questo catalogo in funzione delle necessità operative, per migliorarne la funzionalità o in adeguamento a normativa di legge.

LANDA ILLUMINOTECNICA S.p.A
Via Rosmini, 13/15
25065 Lumezzane
Brescia

+39 0308920966
info@landa.it



8 033239 620499

CATCLASSIE